

**WestminsterResearch**

<http://www.westminster.ac.uk/westminsterresearch>

**Detailed analysis of data from heat pumps installed via the  
Renewable Heat Premium Payment Scheme**

**Gleeson, C.P., Summerfield, A., Biddulph, P., Stone, A., Grainger,  
C., Agnolucci, P., Oikonomou, E. and Lowe, R.**

This is a copy of a report published by the Department of Energy and Climate Change 2016. It is available online at:

[.https://www.gov.uk/government/publications/detailed-analysis-of-data-from-heat-pumps-installed-via-the-renewable-heat-premium-payment-scheme](https://www.gov.uk/government/publications/detailed-analysis-of-data-from-heat-pumps-installed-via-the-renewable-heat-premium-payment-scheme)

---

The WestminsterResearch online digital archive at the University of Westminster aims to make the research output of the University available to a wider audience. Copyright and Moral Rights remain with the authors and/or copyright owners.

---

Whilst further distribution of specific materials from within this archive is forbidden, you may freely distribute the URL of WestminsterResearch: (<http://westminsterresearch.wmin.ac.uk/>).

In case of abuse or copyright appearing without permission e-mail [repository@westminster.ac.uk](mailto:repository@westminster.ac.uk)

# UCL ENERGY

# INSTITUTE

ANALYSIS OF DATA FROM HEAT PUMPS INSTALLED VIA THE RENEWABLE HEAT PREMIUM PAYMENT (RHPP) SCHEME TO THE DEPARTMENT OF ENERGY AND CLIMATE CHANGE (DECC)

## DECC RHPP Detailed Analysis Report

Issued: February 2016

RAPID-HPC authors: Alex Summerfield, Phillip Biddulph, Andrew Stone, Chris Grainger, Paolo Agnolucci, Colin Gleeson, Eleni Oikonomou, Robert Lowe



## Table of contents

Executive Summary .....	8
Context .....	8
Methodology.....	8
Results .....	9
Data checks and quality assurance .....	19
Discussion and implications .....	19
1 Introduction.....	23
2 Methodology .....	26
2.1 Sites included in analysis.....	26
2.2 System boundaries and monitored data parameters .....	28
2.3 Calculating performance at the SEPOMO system boundaries .....	31
2.4 Adjustment to standard weather conditions.....	33
2.5 Performance of alternative technologies .....	35
3 Results.....	39
3.1 Seasonal Performance Factors .....	39
3.2 Savings relative to alternative technologies .....	44
3.3 Variation in monthly performance of HP systems.....	47
3.4 Modes of operation .....	50
3.5 Load factors .....	58
4 Discussion and implications.....	64
5 References .....	68
Appendix A: Stability of performance indicators over time. ....	71
Appendix B: Data and calculation issues .....	82
B.1 Identifying Immersion Heater Electricity Use .....	82
B.2 Incorrect Declared Monitoring Schematic .....	87
B.3 Temperature Sensor Offsets .....	87
B.4 Circulation pump power consumption .....	92

## List of figures

Figure 1. Histograms of $SPF_{H2}$ for ASHPs in Sample B (green), Sample C unadjusted (red) and Sample C adjusted to UKSET conditions (blue).....	11
Figure 2. Histograms of $SPF_{H4}$ for ASHPs in Sample B (green), Sample C unadjusted (red) and Sample C adjusted to UKSET conditions (blue).....	11
Figure 3. Histograms of $SPF_{H2}$ for GSHPs in Sample B (green), Sample C unadjusted (red) and Sample C adjusted to UKSET conditions (blue).....	12
Figure 4. Histograms of $SPF_{H4}$ for GSHPs in Sample B (green), Sample C unadjusted (red) and Sample C adjusted to UKSET conditions (blue).....	12
Figure 5. Histograms for ASHPs and GSHPs with the $SPF_{H2} \geq 2.5$ renewable energy boundary for Sample B (top), Sample C unadjusted (middle) and Sample C adjusted to UKSET conditions (bottom)	14
Figure 2-1. SEPEMO system boundaries (derived from Riviere et al., 2011) with the addition of H5 boundary that accounts for heat losses from the hot water cylinder.....	28
Figure 2-2. An example simplified schematic of the metering arrangement for a monobloc ASHP that provides heat to space heating and a domestic hot water cylinder with an immersion element.....	30
Figure 2-3. An example of a GSHP with an integrated domestic hot water cylinder.....	30
Figure 3-1. Box plots for ASHPs in Sample C of unadjusted SPFs and adjusted SPFs to UKSET conditions (mean indicated by the red line, median by the dashed black line, interquartile range by the blue box).....	41
Figure 3-2. Box plots for GSHPs in Sample C of unadjusted SPFs and adjusted SPFs to UKSET conditions (mean indicated by the red line, median by the dashed black line, interquartile range by the blue box).....	41
Figure 3-3. Box plot of monthly $COP_{H4}$ for ASHPs from Sample B .....	49
Figure 3-4. Air Source Heat Pump (ASHP) Annual Hours of Operation.....	51
Figure 3-5. Ground Source Heat Pump (GSHP) Annual Hours of Operation .....	52
Figure 3-6. Distribution of average hours per day spent in water heating mode (ASHPs) .....	53
Figure 3-7. Distribution of average hours per day spent in water heating mode (GSHPs).....	53
Figure 3-8. Air Source Heat Pump (ASHP) Winter Hours of Operation .....	54

Figure 3-9. Ground Source Heat Pump (GSHP) Winter Hours of Operation .....	55
Figure 3-10. Distribution of hours per day spent in space heating mode for ASHPs during winter months .....	56
Figure 3-11. Distribution of hours per day spent in space heating mode for GSHPs during winter months .....	57
Figure 3-12. Distribution of hours per day spent in space heating or circulating only mode for ASHPs during winter months .....	57
Figure 3-13. Distribution of hours per day spent in space heating or circulating only mode for GSHPs during winter months .....	58
Figure 3-14. Box plots of monthly load factors at H2 system boundary for ASHPs and GSHPs.....	62
Figure 3-15. Box plots of monthly load factors at H4 system boundary for ASHPs and GSHPs.....	63
Figure A-1. Representation of each schematic after selection of sites for each of the samples, compared with the initial RHPP sample (ranked by schemes in Sample C) .....	71
Figure A-2. An example site where the circulation flow rate progressively declined over the monitoring period .....	72
Figure A-3. The percentage difference in circulation flow rates between the 1 <sup>st</sup> and 13 <sup>th</sup> month, where these are the minimum such difference and were the basis for that 13 month period being selected for sites in Sample C .....	72
Figure A-4. Sample B sites with $SPF_{H4}$ over time (note the $SPF_{H4}$ is an annual efficiency obtained for each Site plotted at the last month of data used) .....	73
Figure A-5. Scatter plot comparing $SPF_{H4}$ from sites in Sample C with the corresponding adjusted values under UKSET conditions (where ASHPs are shown in red, GSHPs in blue) .....	74
Figure A-6. Histograms of $SPF_{H2}$ for ASHPs in Sample B (green), Sample C unadjusted (red) and Sample C adjusted to UKSET conditions (blue).....	74
Figure A-7. Histograms of $SPF_{H4}$ for ASHPs in Sample B (green), Sample C unadjusted (red) and Sample C adjusted to UKSET conditions (blue).....	75
Figure A-8. Histograms of $SPF_{H2}$ for GSHPs in Sample B (green), Sample C unadjusted (red) and Sample C adjusted to UKSET conditions (blue).....	75
Figure A-9. Histograms of $SPF_{H4}$ for GSHPs in Sample B (green), Sample C unadjusted (red) and Sample C adjusted to UKSET conditions (blue).....	76

Figure A-10. Histograms for ASHPs and GSHPs with the  $SPF_{H2} \geq 2.5$  renewable energy boundary for Sample B (top), Sample C unadjusted (middle) and Sample C adjusted to UKSET conditions (bottom) 76

Figure A-11. Histograms of annual CO<sub>2</sub> savings for GSHPs when replacing gas, oil, electricity (E7), Coal, LPG, and Electricity (standard tariff) with data from Sample C adjusted to UKSET ..... 77

Figure A-12. Histograms of annual CO<sub>2</sub> savings for ASHPs when replacing gas, oil, electricity (E7), Coal, LPG, and Electricity (standard tariff) with data from Sample C adjusted to UKSET ..... 78

Figure A-13. Histograms of mean annual fuel cost savings (£) for GSHPs when replacing gas, oil, electricity (E7), Coal, LPG, and Electricity (standard tariff) with data from Sample C adjusted to UKSET ..... 78

Figure A-14. Histograms of mean annual fuel cost savings (£) for ASHPs when replacing gas, oil, electricity (E7), Coal, LPG, and Electricity (standard tariff) with data from Sample C adjusted to UKSET ..... 79

Figure A-15. Histograms of annual CO<sub>2</sub> savings for GSHPs under the CO<sub>2</sub> +10% scenario of increased space heating when replacing gas, oil, electricity (E7), Coal, LPG, and Electricity (standard tariff) with data from Sample C adjusted to UKSET..... 79

Figure A-16. Histograms of annual CO<sub>2</sub> savings for ASHPs under the CO<sub>2</sub> +10% scenario of increased space heating when replacing gas, oil, electricity (E7), Coal, LPG, and Electricity (standard tariff) with data from Sample C adjusted to UKSET..... 80

Figure A-17. Histograms of mean annual fuel cost savings (£) for GSHPs under the CO<sub>2</sub> +10% scenario of increased space heating when replacing gas, oil, electricity (E7), Coal, LPG, and Electricity (standard tariff) with data from Sample C adjusted to UKSET ..... 80

Figure A-18. Histograms of mean annual fuel cost savings (£) for ASHPs under the CO<sub>2</sub> +10% scenario of increased space heating when replacing gas, oil, electricity (E7), Coal, LPG, and Electricity (standard tariff) with data from Sample C adjusted to UKSET ..... 81

## List of tables

Table 1. Mean SPF<sub>s</sub> for HP systems in Sample B, Sample C unadjusted, and Sample C adjusted to UKSET conditions ..... 10

Table 2. Adjusted Mean SPF<sub>s</sub> for Sample C compared with the Preliminary Findings (using data from December 2013) and from EST HP Trial Phase I (SPF<sub>H5</sub>) and Phase II (SPF<sub>H4</sub>). ..... 10

Table 3. Percentage of HP systems that met the  $SPF_{H2} \geq 2.5$  criterion defined in the EU Renewable Energy Directive ..... 14

Table 4. Estimated mean renewable heat outputs (from Sample C, adjusted to UKSET conditions).....	15
Table 5. Carbon intensities and fuel costs used to determine the $SPF_{H4}$ of an HP system (on standard tariff electricity) needed in order to outperform other fuels.....	16
Table 6. Mean annual CO <sub>2</sub> savings and percentage of HP systems under UKSET conditions likely to yield CO <sub>2</sub> reductions relative to other fuels (including 10% increased space heating demand scenario).....	17
Table 7. Mean annual fuel cost savings and percentage of HP systems expected to yield energy cost savings relative to other fuels (including a scenario with 10% increased heat demand).....	18
Table 1-1. Forthcoming publications.....	23
Table 2-1. The complete set of parameters included in the monitored data.....	29
Table 2-2. Carbon intensities and fuel costs used to determine the $SPF_{H4}$ of an HP system (on standard tariff electricity) needed in order to outperform other fuels.....	37
Table 3-1. Mean SPF <sub>H2</sub> for HP systems in Sample B, Sample C unadjusted, and Sample C adjusted to UKSET conditions.....	39
Table 3-2. Estimated SPF <sub>H2</sub> for ASHPs and GSHPs using weather corrected data.....	40
Table 3-3. Adjusted Mean SPF <sub>H2</sub> for Sample C compared with the Preliminary Findings (using data from December 2013) and from EST HP Trial Phase I ( $SPF_{H5}$ ) and Phase II ( $SPF_{H4}$ ).....	42
Table 3-4. Percentage of HP systems that met the $SPF_{H2} \geq 2.5$ criterion under the EU Renewable Energy Directive (with upper and lower limits based on the standard error in the population mean estimates of $SPF_{H2}$ ).....	43
Table 3-5. Estimated renewable heat outputs (from Sample C, adjusted to UKSET conditions).....	44
Table 3-6. Percentage of different fuels actually replaced in the RHPP sample.....	45
Table 3-7. Mean annual CO <sub>2</sub> savings and percentage of HP systems under UKSET conditions likely to yield CO <sub>2</sub> reductions relative to other fuels (including 10% increased space heating demand scenario)....	46
Table 3-8. Mean annual fuel cost savings and percentage of HP systems expected to yield energy cost savings relative to other fuels (including a scenario with 10% increased heat demand).....	47
Table 3-9. Summary statistics of number of hours in each operating mode (annual, all figures in hours) .	52
Table 3-10. Summary statistics of number of hours in each operating mode (winter).....	55
Table 3-11. Hours per day spent in space heating mode for ASHPs and GSHPs during winter months .	58

Table 3-12. Annual load factors (%) at the H2 boundary .....	59
Table 3-13. Annual load factors (%) at the H4 boundary .....	59
Table 3-14. Winter load factors (%) at the H2 boundary.....	60
Table 3-15. Winter load factors (%) at the H4 boundary.....	60



## Nomenclature

### PERFORMANCE EFFICIENCY NOMENCLATURE

COP Heat pump (HP) coefficient of performance

SPF<sub>Hn</sub> HP seasonal performance factor for heating at SEPEMO boundary Hn

### MONITORED VARIABLES

E <sub>b</sub>	Electricity for whole system boost only
E <sub>dhw</sub>	Electricity for domestic hot water (typically an immersion heater)
E <sub>hp</sub>	Electricity for the heat pump unit (may include a booster heater and circulation pump)
E <sub>sp</sub>	Electricity for boost to space heating only
F <sub>hp</sub>	Flow rate of water from heat pump (may be space heating only)
F <sub>hw</sub>	Flow rate of water to DHW cylinder (if separately monitored)
H <sub>hp</sub>	Heat from heat pump (may be space heating only)
H <sub>hw</sub>	Heat to DHW cylinder (if separately monitored)
T <sub>co</sub>	Temperature of water leaving the condenser
T <sub>in</sub>	For ASHP: Temperature of refrigerant leaving the evaporator For GSHP: Temperature of ground loop water into the heat pump
T <sub>sf</sub>	Flow temperature of water to space heating
T <sub>wf</sub>	Flow temperature of water to cylinder

(Note that external temperature, T<sub>ex</sub>, was not measured directly. Data from a publicly available database were used in the analysis.)

### RHPP ENERGY AND POWER UNITS

Energy	J	Joule	SI unit of energy
Energy	kWh	3.6 MJ	Customary unit of energy for residential energy use
Energy	MWh, GWh	3.6 GJ, 3.6 TJ	
Power	W	Watt, J/s	SI unit of power and heat flow
Power	Wh/2 minutes	30 W	Base unit of energy for monitored data in RHPP trial, limit of resolution of power – note that power and heat have been recorded at 2 minute intervals
Power	kWh/year	3.6 MJ/year 0.11416 W	Customary unit for rate of residential energy use
Power	kW	1000 W	Typical unit for measurement of heating system ratings

### KEY ACRONYMS AND ABBREVIATIONS

DECC	Department of Energy and Climate Change
EST	Energy Saving Trust
Preliminary Assessment	Preliminary assessment of the RHPP data performed by DECC (Wickins, 2014)
RAPID-HPC	Research and Analysis on Performance and Installation Data – Heat Pump Consortium
RHPP	Renewable Heat Premium Payment Scheme
SEPEMO	SEasonal PErformance factor and MOnitoring

## Executive Summary

### Context

The need to develop the UK supply for domestic heat pumps (HPs) and to evaluate the empirical performance of HP systems in the field has led to the establishment of two major UK field trials of HPs since 2000. The first took place in two phases: Phase I, conducted by the Energy Saving Trust between 2008 and 2010 (EST, 2010; Dunbabin & Wickins, 2012) and Phase II, conducted by EST and DECC between 2011 and 2012 (Dunbabin et al. 2013). The second field trial, which is the subject of this report, was established by DECC in conjunction with the Renewable Heat Premium Payment (RHPP) grant scheme, which ran from 2011 to 2014 (DECC, 2014). This scheme was designed to support the replacement of fossil-fired and electric resistance heating systems with heat pumps in dwellings not supplied with natural gas - most of the RHPP installations replaced either electric resistance or oil-fired heating systems. They included several makes and types of ground-source HP systems (GSHPs) and air-source HP systems (ASHPs), located in a range of domestic properties across GB. The RHPP heat pump trial monitored systems at just over 700 of these sites as the basis for an evaluation their performance. In December 2014, data for 699 sites were passed to the RAPID-HPC for detailed analysis.

The aim of this report is to build on a preliminary analysis that was undertaken by DECC (Wickins, 2014) to provide the most up-to-date picture of the overall performance of HP systems in the RHPP sample, primarily in terms of the distribution of Seasonal Performance Factors (SPFs) at various system boundaries, under standard UK weather conditions. In addition, it provides estimates of the extent of renewable energy generation as defined under the EU Renewable Energy Directive, expected carbon and energy cost savings from these HP systems in comparison with the use of other fuels, and statistics such as annual load factors.

### Methodology

Key aspects of the work and results presented here are:

- The selection for analysis of two large samples of sites from the full dataset, that had sufficient data quality needed for calculation of SPFs at various system boundaries, which measure *the annual efficiency* of the HP system according to an established methodology developed across Europe (Riviere et al. 2011). The calculation of SPFs requires reliable monitoring data extending across at least one complete year. Sample and data selection processes addressed such issues as missing data and extended periods when the HP system appears to be unused (possibly due to the dwelling being unoccupied for a period).
- The adjustment of the results to a set of standard external weather conditions, referred to as the UK Standard External Temperature (UKSET) and chosen to match temperatures used in the Standard Assessment Procedure (SAP) as closely as possible. The resultant adjusted data have

been used for much of the subsequent analysis to obtain aggregate statistics, which are independent of the particular weather conditions that obtained during the RHPP trial data gathering phase.

Of the total 699 sites in the RHPP sample supplied to RAPID-HPC (referred to as “Sample A”), 99 sites were excluded at the outset of the project due to technical issues and a further 104 sites were omitted due to missing data streams and other issues affecting the calculation of SPFs. The RHPP sample available for consideration in this analysis therefore comprised 496 sites. A further series of checks and filters were then applied to generate two sub-samples:

- **Sample B (Broad) with 391 sites** (297 ASHP and 94 GSHPs) with sufficiently complete and stable (based on circulation rates) monitoring data of the HP system over a year to enable calculation of SPFs. The specific annual period selected for SPF analysis differs from site to site.
- **Sample C (Concurrent data) with 299 sites** (223 ASHP and 76 GSHPs) is a subset of sites in Sample B, but where data from the same annual monitoring period of 1/11/2013 to 31/10/2014 was selected. Sample C was used for adjustment of data to calculate the SPFs under UKSET conditions.

## Results

Table 1 summarises findings for mean SPFs for Sample B and Sample C, with the latter also showing the performance estimates after adjustment to UKSET conditions. Even though the selection criteria for Sample B allowed for the inclusion of sites with a considerable proportion of missing data and with different annual periods for the evaluation, no statistical difference is evident in the mean SPFs across the various system boundaries compared with those based on Sample C. GSHPs have consistently higher mean performance than ASHPs in both samples, the difference being around 0.3 for  $SPF_{H2}$  and around 0.4-0.45 for  $SPF_{H4}$ . More generally, the mean SPFs showed the expected pattern of decline in nominal efficiency as the system boundaries are widened, with  $SPF_{H2}$  having the highest, and  $SPF_{H5}$  having the lowest performance. The annual data used for Sample C corresponded to winter weather conditions that were unusually warm for the UK. The mean SPFs for Sample C adjusted to UKSET conditions (Table 1) tend to be slightly lower than the unadjusted values for ASHPs, while adjusted SPFs for GSHPs are in agreement with the unadjusted values. This is consistent with the expectation that the performance of ASHPs would be more sensitive to external temperatures. The shape of the distributions of SPFs for Sample C are essentially unchanged after adjustment to UKSET conditions (Figures 1 to 4).

Although adjustment of statistics from Sample C to UKSET conditions has resulted in a relatively small change to the SPFs, the adjusted data have been used in much of subsequent analysis below. However, when examining heat pump characteristics in detail, we have used the unadjusted data.. This allows us to use more data, over a longer period, and avoids the interpretational complexities involved in basing detailed analysis on modelled data. Note that results for Sample B and the adjusted results for Sample C are very similar. The dataset used in each stage of the analysis has been noted throughout this report.

**Table 1. Mean SPF<sub>s</sub> for HP systems in Sample B, Sample C unadjusted, and Sample C adjusted to UKSET conditions**

SPF	HP type	Sample B		Sample C		UKSET adjusted
		N	Mean (± Std. Error)	N	Mean (± Std. Error)	Mean (± Std. Error)
<b>SPF<sub>H2</sub></b>	ASHP	297	2.59 (±0.04)	223	2.61 (±0.04)	2.56 (±0.04)
	GSHP	94	2.91 (±0.08)	76	2.93 (±0.10)	2.92 (±0.10)
<b>SPF<sub>H3</sub></b>	ASHP	297	2.44 (±0.04)	223	2.44 (±0.03)	2.38 (±0.03)
	GSHP	94	2.90 (±0.08)	76	2.92 (±0.10)	2.91 (±0.10)
<b>SPF<sub>H4</sub></b>	ASHP	297	2.36 (±0.04)	223	2.36 (±0.03)	2.30 (±0.03)
	GSHP	94	2.75 (±0.07)	76	2.76 (±0.09)	2.75 (±0.09)
<b>SPF<sub>H5</sub></b>	ASHP	297	2.23 (±0.04)	223	2.23 (±0.03)	2.18 (±0.03)
	GSHP	94	2.51 (±0.07)	76	2.49 (±0.08)	2.48 (±0.08)

**Table 2. Adjusted Mean SPF<sub>s</sub> for Sample C compared with the Preliminary Findings (using data from December 2013) and from EST HP Trial Phase I (SPF<sub>H5</sub>) and Phase II (SPF<sub>H4</sub>).**

SPF	HP type	Sample C adjusted		Prelim. Findings (Dec. 2013) <sup>a</sup>		EST HP Field Trial Phase I & II	
		N	Mean (± Std. Error)	N	Mean (± Std. Error)	N	Mean (± Std. Error)
<b>SPF<sub>H4</sub></b>	ASHP	223	2.30 (±0.03)	289	2.43 (±0.04)	15	2.45 <sup>b</sup> (±0.11)
	GSHP	76	2.75 (±0.09)	124	2.92 (±0.08)	22	2.82 <sup>b</sup> (±0.10)
<b>SPF<sub>H5</sub></b>	ASHP	223	2.18 (±0.03)	289	2.34 (±0.04)	22	1.84 <sup>c</sup> (±0.09)
	GSHP	76	2.48 (±0.08)	124	2.74 (±0.08)	49	2.39 <sup>c</sup> (±0.08)

<sup>a</sup> As reported in the Preliminary report from the RHPP heat pump metering programme (Wickins, 2014)

<sup>b</sup> SPF<sub>H4</sub> reported in findings of Phase II of the EST Heat Pump Field Trials (Dunbabin et al., 2013)

<sup>c</sup> SPF<sub>H5</sub> reported in findings of Phase I of the EST Heat Pump Field Trials (Dunbabin & Wickins, 2012)

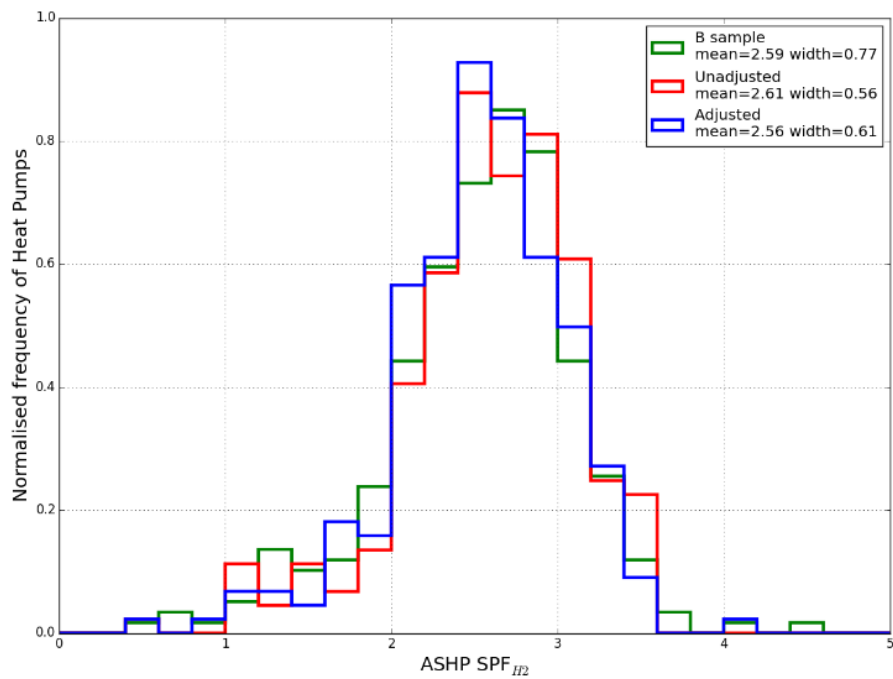


Figure 1. Histograms of  $SPF_{H2}$  for ASHPs in Sample B (green), Sample C unadjusted (red) and Sample C adjusted to UKSET conditions (blue)

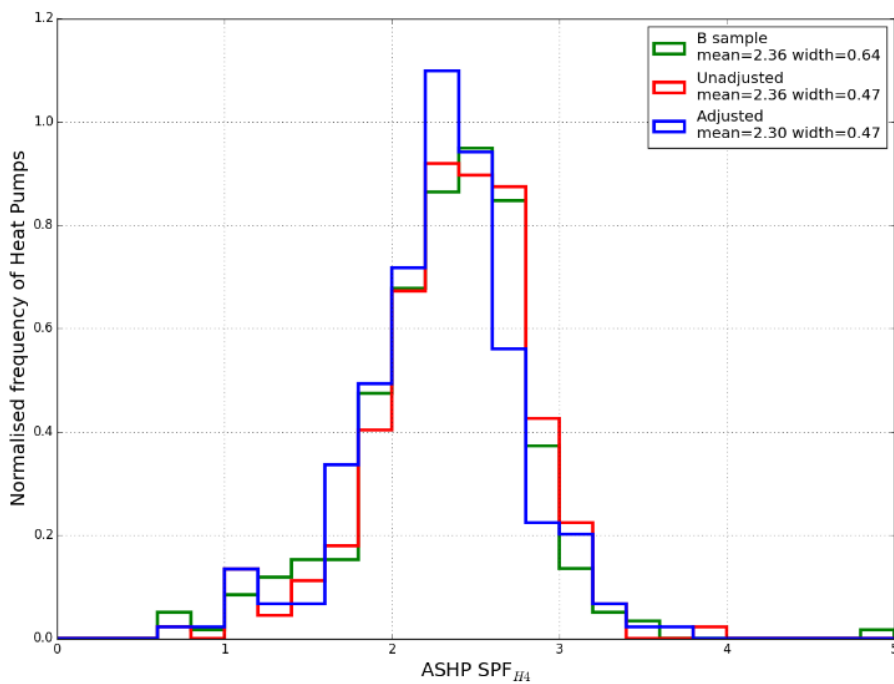
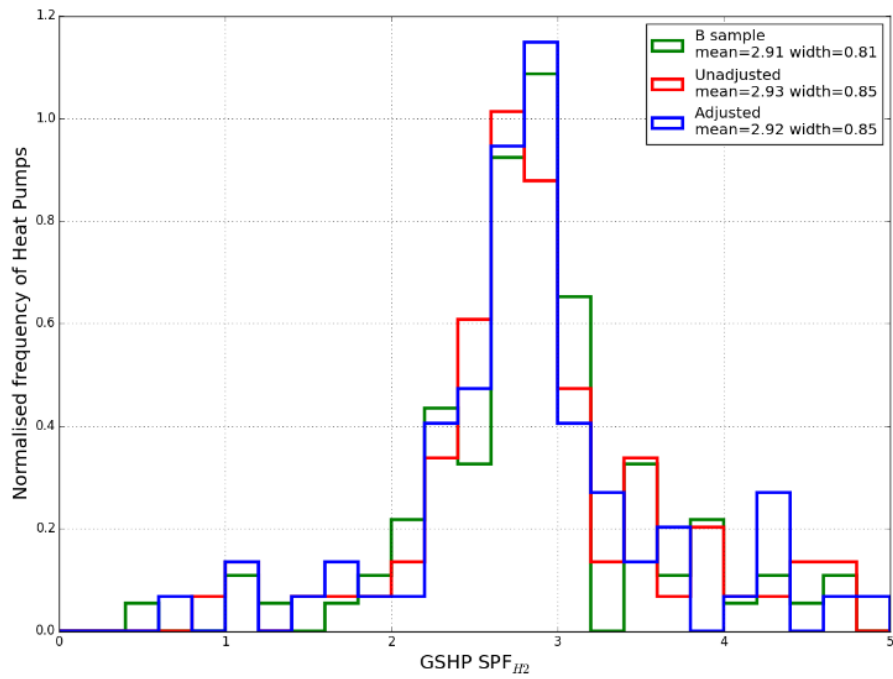
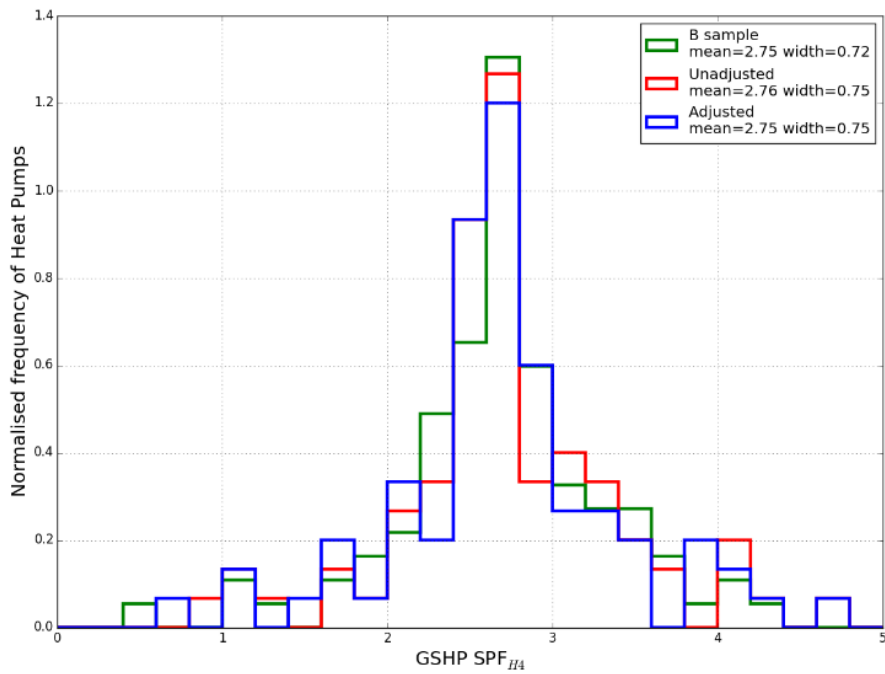


Figure 2. Histograms of  $SPF_{H4}$  for ASHPs in Sample B (green), Sample C unadjusted (red) and Sample C adjusted to UKSET conditions (blue)



**Figure 3. Histograms of  $SPF_{H2}$  for GSHPs in Sample B (green), Sample C unadjusted (red) and Sample C adjusted to UKSET conditions (blue)**



**Figure 4. Histograms of  $SPF_{H4}$  for GSHPs in Sample B (green), Sample C unadjusted (red) and Sample C adjusted to UKSET conditions (blue)**

In comparison with previous findings from the UK, the results for  $SPF_{H4}$  adjusted to UKSET conditions presented in Table 2 are lower than those from the preliminary report on the RHPP metering data (Wickins, 2014). This is likely due to these early estimates for annual performance being based on just one month of winter data, specifically from December 2013. The mean  $SPF_{H4}$  figures are also slightly lower than reported for the EST HP Phase II field trials (Dunbabin et al. 2013), however this may be due to differences in study design, since most of the EST HP Phase II were the subject of interventions to address performance issues revealed by Phase I monitoring<sup>1</sup>. While Phase I of the EST HP field trials does provide a more comparable snapshot of HP system performance, it uses an estimate of  $SPF_{H5}$  to measure performance. This analysis uses the same basic assumption of 30% heat losses from the hot water cylinder as was done in the preliminary analysis of RHPP data, but it should be noted that the relationship between heat loss and hot water drawn from the cylinder is in principle complex, and the assumption of a simple proportional relationship may not be correct. The resultant mean  $SPF_{H5}$  for ASHPs are considerably higher than for Phase I of the EST trial (which had in turn shown markedly improved performance by Phase II), whereas results for GSHPs are in agreement within the estimated statistical margin of error.<sup>2</sup>

In terms of the estimates for renewable energy generated by HP systems in accordance with the EU Renewable Energy Directive, the EU Commission Decision of 1<sup>st</sup> March 2013 defines the relevant measure of efficiency to be  $SPF_{H2}$ , i.e. the efficiency of the heat pump without the inclusion of electricity used for backup or for circulation and heat distribution pumps. The Directive considers electric heat pumps to be classed as a renewable energy source provided that  $SPF_{H2} \geq 2.5$ .

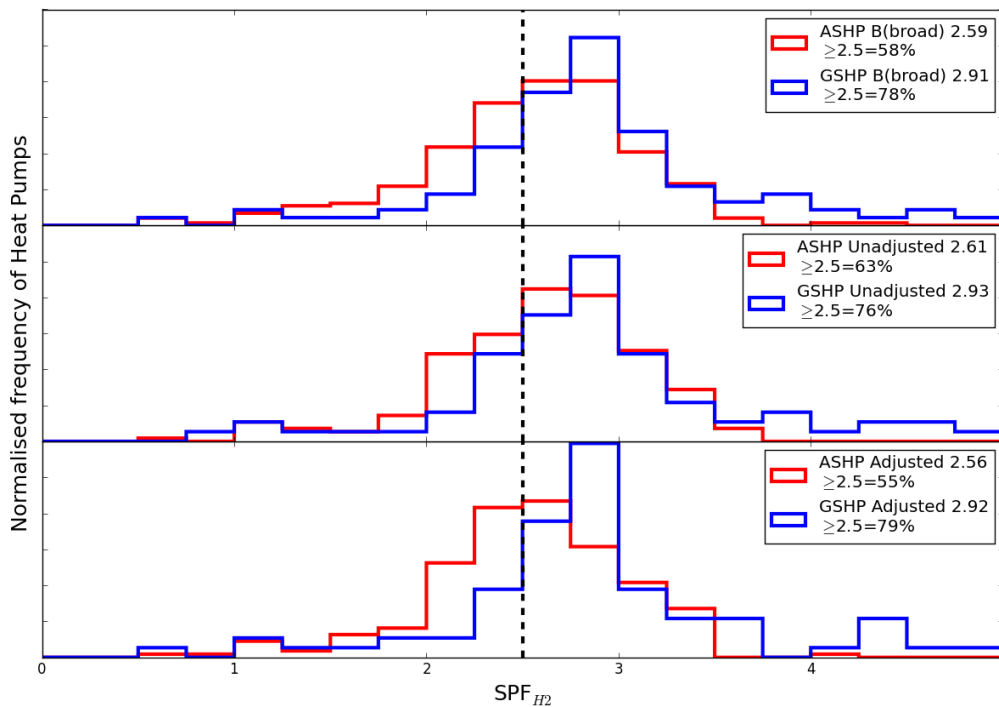
---

<sup>1</sup> The EST Phase II study included 44 sites. Interventions were carried out to improve performance on 32 of these sites. Of these interventions, 12 were described as major, 9 as medium and 11 as minor.

<sup>2</sup> Note that we have not attempted a full analysis of errors for SPF's presented in this report. Statistical errors are for guidance only. They exclude systematic errors and will therefore tend to underestimate total error.

**Table 3. Percentage of HP systems that met the  $SPF_{H2} \geq 2.5$  criterion defined in the EU Renewable Energy Directive**

Sample	HP type	Percentage $SPF_{H2} \geq 2.5$	95% Confidence interval
Sample B	ASHP	58%	52 – 64%
	GSHP	78%	68 – 88%
Sample C	ASHP	63%	55 – 71%
	GSHP	76%	66 – 86%
Sample C Adjusted	ASHP	55%	49 – 61%
	GSHP	79%	69 – 89%



**Figure 5. Histograms for ASHPs and GSHPs with the  $SPF_{H2} \geq 2.5$  renewable energy boundary for Sample B (top), Sample C unadjusted (middle) and Sample C adjusted to UKSET conditions (bottom)**



From Table 3 and based on the distributions obtained for  $SPF_{H2}$  as shown in Figure 5, findings for Sample C under UKSET conditions indicate that 55% of ASHPs and 79% of the GSHPs can be classified as sources of renewable energy. The figure for ASHPs appears lower (but still within the 95% confidence interval) than for unadjusted data from Sample C (63%), which were for a relatively warm year (Meteorological Office, 2014). As would be expected, the results for Sample B are in closer agreement with the adjusted figures, given that this sample uses data for the SPF calculations from different annual periods according to the data quality available at each site and hence is less affected by any particular year. As the threshold value for classification as a renewable energy source is close to the mean and the median for ASHPs, small changes after adjustment to UKSET conditions can result in relatively large shifts in the percentage attaining the threshold value of  $SPF_{H2} \geq 2.5$ . For these figures to be generalised to the current stock of heat pumps, it must be assumed that sample on which it is based is representative of the stock of HP systems in the UK. In all cases, however, the results here indicate that a large proportion (between a third and just under a half) of ASHPs and just over 20% of GSHPs were not operating with sufficient efficiency to be classified as renewable sources of energy.

To give an indication of the renewable heat generated under UKSET conditions (Table 4), on average ASHPs with  $SPF \geq 2.5$  produced 10,000 kWh each, whereas if this output were shared across the whole sample (i.e. including sites that did not attain the required level of efficiency) then the mean renewable heat output almost halved to 5,000 kWh. The corresponding figures for GSHPs were markedly higher, at 14,600 kWh and 11,500 kWh respectively, reflecting the higher proportion of sites classified as contributing to renewable energy generation.

**Table 4. Estimated mean renewable heat outputs (from Sample C, adjusted to UKSET conditions)**

HP type	N	%	Sites with $SPF_{H2} \geq 2.5$	All sites
			Mean renewable heat output, kWh	Mean renewable heat output, kWh
ASHP	223	55%	10,000 ( $\pm 450$ )	5,500 ( $\pm 300$ )
GSHP	76	79%	14,600 ( $\pm 1,500$ )	11,500 ( $\pm 1,350$ )

**Table 5. Carbon intensities and fuel costs used to determine the  $SPF_{H4}$  of an HP system (on standard tariff electricity) needed in order to outperform other fuels**

Fuel <sup>a</sup>	Carbon intensity (gCO <sub>2</sub> /kWh)	Fuel cost (p/kWh)	System efficiency	SPF <sub>H4</sub> needed for reduction in CO <sub>2</sub> emissions	SPF <sub>H4</sub> needed for fuel cost reduction
<b>LPG</b>	215 <sup>b</sup>	8.32 <sup>c</sup>	85%	1.43	1.54
<b>Electricity (economy 7)</b>	362 <sup>b,d</sup>	7.89 <sup>e,f</sup>	100%	1.00	1.91
<b>Oil</b>	247 <sup>b</sup>	5.80 <sup>b,f</sup>	84%	1.23	2.19
<b>Coal</b>	344 <sup>b</sup>	5.30 <sup>b,f</sup>	60%	0.63	1.71
<b>Gas</b>	185 <sup>b</sup>	4.80 <sup>b,f</sup>	85%	1.66	2.67
<b>Electricity (standard)</b>	362 <sup>b,d</sup>	15.10 <sup>b,f</sup>	100%	1.00	1.00

<sup>a</sup> Selected fuels potentially displaced by HP systems (using electricity on the standard tariff), where gas is included only as an indicator of the current best performer among non-renewable fuels.

<sup>b</sup> Source: Green Book supplementary guidance: valuation of energy use and greenhouse gas emissions for appraisal, DECC, last updated 2<sup>nd</sup> October 2014

<sup>c</sup> Source: <http://www.energysavingtrust.org.uk/domestic/content/our-calculations> – February 2015

<sup>d</sup> Note this is an indicative marginal value, not a current grid average, which is significantly higher - see DECC 2015b. The figure of 0.362 is the mean marginal factor for the four year period 2011-2014 (see accompanying tables Data\_tables\_1-20\_supporting\_the\_toolkit\_and\_the\_guidance.xlsx). This document suggests a continuous decline in carbon intensity for grid electricity over the coming decades, and a convergence of marginal and average values. The marginal intensity is projected to fall to around 0.282 in 2020 and to around 0.129 g(CO<sub>2</sub>)/kWh in 2030.

<sup>e</sup> Source: Average variable unit costs and fixed costs for electricity for selected towns and cities in the UK, DECC, last updated 26<sup>th</sup> March 2015, table 2.2.4, night price 6.48p/kWh, day price: 15.88 p/kWh, percentage used at day rate: 15%, based on SAP 2012 table 11 (BRE, 2013).

<sup>f</sup> 2011-2014 mean.

Table 5 provides an indication of the  $SPF_{H4}$  needed for HP systems either to result in CO<sub>2</sub> emissions reductions (based on current carbon intensities of each fuel) or in annual fuel cost reductions (based on recent fuel prices).  $SPF_{H4}$  has been selected for this comparison as it takes account of all electricity use for the delivery of heating and hot water and therefore is the most appropriate metric to use when assessing bills and carbon dioxide emissions.

Note that the RHPP scheme is not intended to promote the use of HP systems to displace gas condensing boilers, rather this fuel has been included as a benchmark because of its dominance in the UK and as the best performing conventional heating technology in terms of both CO<sub>2</sub> emissions and fuel costs (Palmer & Cooper, 2013). Even at the given carbon intensity for electricity, the  $SPF_{H4}$  needed to reduce CO<sub>2</sub> emissions is less than 1.5 for all fuels except gas (where the  $SPF_{H4}$  breakeven point is 1.66).

The performance requirements to result in fuel cost reductions are somewhat more demanding, though the only fuels that require a breakeven  $SPF_{H4}$  of over 2.0 are oil (2.19) and gas (2.67).

**Table 6. Mean annual CO<sub>2</sub> savings and percentage of HP systems under UKSET conditions likely to yield CO<sub>2</sub> reductions relative to other fuels (including 10% increased space heating demand scenario)**

Displaced fuel <sup>a</sup>	ASHP mean CO <sub>2</sub> savings (Tonnes)		GSHP mean CO <sub>2</sub> savings (Tonnes)	
	CO <sub>2</sub>	CO <sub>2</sub> +10% <sup>b</sup>	CO <sub>2</sub>	CO <sub>2</sub> +10% <sup>b</sup>
Electricity (Std.)	2.0 (99%)	1.8 (99%)	3.3 (99%)	3.0 (97%)
Electricity (E7)	2.0 (99%)	1.8 (99%)	3.3 (99%)	3.0 (97%)
Coal	4.1 (100%)	3.7 (100%)	6.3 (99%)	5.8 (99%)
Oil	1.3 (96%)	1.1 (96%)	2.4 (96%)	2.1 (96%)
LPG	1.0 (95%)	0.8 (94%)	1.8 (96%)	1.6 (95%)
Gas <sup>c</sup>	0.6 (93%)	0.5 (87%)	1.3 (95%)	1.1 (91%)

<sup>a</sup> Carbon intensity used for the fuels displaced are as given in Table 4, with HP systems using the carbon intensity of electricity (with this the same for both the standard and E7 tariff)

<sup>b</sup> The calculation is repeated allowing for a 10% increase in space heating demand with heat pumps. This recognises the potential for higher mean internal temperatures in dwellings with heat pumps resulting from a shift towards continuous heating.

<sup>c</sup> Gas is included only as a benchmark indicator of the current in-use best performer (condensing boilers) in terms of cost and among current non-renewable fuel heating systems.

Table 6 shows the annual mean CO<sub>2</sub> savings (using the carbon intensities and other specifications given in Table 5 and not over the installed life) and the estimated proportion of sites that result in CO<sub>2</sub> reductions. These figures are based on the distributions of heat output and electricity input obtained for Sample C under UKSET conditions. The “CO<sub>2</sub> +10%” column represents the case where the mean internal temperature increases by about 1°C when a heat pump is installed. This recognises the potential for higher mean internal temperatures in dwellings with heat pumps resulting from a shift towards continuous heating. Such a shift would necessary to achieve the same internal temperatures during heating-on periods that would have been achieved by a boiler fired with oil, LPG or natural gas, due to the lower heat output rating of a heat pump compared with such systems. Note that internal temperatures were not monitored in this study, so it is not known whether this effect occurs or not. Also note that the RHPP scheme was focussed on dwellings off the gas grid; however, an assessment of the carbon savings relative to natural gas used in a condensing boiler has also been included because of its dominance in the UK and as the current best performing heating technology in terms of both CO<sub>2</sub> emissions and fuel costs

(Palmer & Cooper, 2013). The findings indicate that even under the increased heating demand scenario over 94% of ASHPs and 95% of GSHPs have reduced CO<sub>2</sub> emissions compared with the use of electricity, coal, oil, and LPG. Annual mean CO<sub>2</sub> savings per site (for fuels other than gas) are substantial even for ASHPs, varying from 4.1 Tonnes for coal to 1.0 Tonne CO<sub>2</sub> for LPG. The CO<sub>2</sub> +10% scenario, which assumes increased space heating with HP systems lowers these savings slightly.

**Table 7. Mean annual fuel cost savings and percentage of HP systems expected to yield energy cost savings relative to other fuels (including a scenario with 10% increased heat demand)**

Displaced fuel <sup>a</sup>	ASHP mean cost savings (£)		GSHP mean cost savings (£)	
	(% sites with savings)		(% sites with savings)	
	Cost	Cost +10%	Cost	Cost +10%
<b>Electricity (Std)</b>	845 (99%)	731 (99%)	1388 (99%)	1255 (97%)
<b>Electricity (E7)</b>	146 (82%)	98 (73%)	372 (89%)	307 (89%)
<b>Coal</b>	232 (92%)	171 (84%)	500 (93%)	426 (91%)
<b>Oil</b>	70 (64%)	39 (46%)	242 (83%)	190 (79%)
<b>LPG</b>	323 (95%)	252 (93%)	634 (95%)	549 (93%)
<b>Gas</b>	12 (19%)	4 (9%)	98 (53%)	68 (34%)

<sup>a</sup> Fuel costs for each of the displaced fuels are set as given in Table 4, with HP systems using the standard electricity tariff.

<sup>b</sup> The calculation is repeated, but allowing for a 10% increase in heating demand. This recognises the potential for higher mean internal temperatures in dwellings with heat pumps resulting from a shift towards continuous heating.

<sup>c</sup> Gas is included only as an indicator of the current best performing technology in terms of cost and CO<sub>2</sub> emissions.

Estimated fuel cost savings are shown in Table 7 in a single year (using the costs and other specifications given in Table 5 and not over the installed life), where HP systems use electricity at the standard tariff. It is estimated that at least 89% of GSHPs and 82% of ASHPs would have reduced household bills compared against electricity, LPG and coal, though the figures drop markedly for oil (e.g. 64% for ASHPs). Note also that oil prices have fallen since the date selected for this analysis (October 2014). The findings indicate annual mean cost savings per site vary widely, for instance for ASHPs savings are from £845 for standard electricity to £70 for oil (considering fuels other than natural gas). The Cost+10%

scenario covering increased space heating with HP systems lowers these savings considerably in some cases, for example down to £39 per year for oil replaced by ASHPs.

## Data checks and quality assurance

Whilst considerable emphasis in the development of SPF measurement has occurred in terms of the definition of system boundaries and meter placements (Riviere et al., 2011), the established methodology is less clear in terms of requirements with respect to missing data and minimum operation requirements for this metric of annual performance levels. This is addressed here with the strategy of obtaining two samples, with the inclusive larger Sample B with high thresholds for omission due to missing data and the more restrictive Sample C that requires concurrent annual monitoring data. No evidence has been found to suggest that either the selection criteria applied for both Sample C and Sample B or the adjustment to UKSET conditions have biased or unduly affected the results:

- Both Sample B and Sample C contain similar proportions of sites from each of the main schematic categories, compared with the RHPP monitoring sample. Schematics describe the arrangement of sensors used in the monitoring of heat pumps of the various configurations encountered in the RHPP sample - examples are presented in section 2.2 and in Appendix B.
- Comparison of individual site SPFs from Sample C with the adjusted SPFs from under UKSET conditions shows that only 5% of ASHPs had changes of more than 20%, with minimal changes for GSHPs.
- As expected, findings for Sample B and those from Sample C adjusted to UKSET conditions are in close agreement, which is consistent with use of a range of annual data selected over the study period from each site in Sample B (and so across that sample as a whole are more likely to be in response to external conditions that are similar to UKSET).
- Histograms of SPFs for each of the samples show highly similar distributions, where unacceptable bias would tend to skew one compared with another.
- Examining the variation in SPFs according to the period selected for sites in Sample B, shows no evidence of substantive changes in performance over the entire monitoring period.

Overall, these checks and the broadly similar distributions of SPFs evident for Sample B and Sample C (whether or not adjusted to UKSET conditions) suggest that they provide an acceptable basis for analysis and the generation of summary statistics. While potential systemic issues remain, such as representativeness of the sample with respect to the UK, and the effect of antifreeze on heat meter calibration, they are likely to affect results *from all RHPP samples in much the same way*. These issues with their implications for future work are discussed in the next sections.

## Discussion and implications

RHPP field trial of HP systems undertaken by DECC has sufficient scale (sample size and duration), scope (range of HP systems and installation sites), and depth (high frequency monitoring data at key

points across system boundaries) to provide the foundation for wide ranging technical evaluation of HP systems. The process of data quality assessment for sample selection, suggests that findings presented in this report, such as the qualitative implications from summary statistics for SPFs and other performance measures of HP systems, should be useful for policy development. Furthermore, the analysis here has shown the first steps for a more detailed description that can provide insights on heat pump operation, as well as the identification of potential issues impacting on the monitoring and performance of specific groups of ASHP and GSHP systems. The results and their implications in this report, however, need to be caveated with regard to remaining systemic issues, which include:

- the extent to which the RHPP sample is representative of the UK stock of HP systems - while we do not have information to check if this the case, the RHPP sample is geographically spread, includes owner occupied and social housing, and covers a range of dwelling construction types, sizes and ages. This suggests that the RHPP sample is broadly representative of the ~14,000 domestic heat pumps installed via the RHPP.
- the likelihood of overestimation of heat output and therefore of SPF due to the presence of antifreeze in primary heat distribution circuits. In individual heat pumps where this is the case, estimates of SPF may have been overestimated by as much as 7%<sup>3</sup>.
- a tendency for flow rates recorded by heat meters to decline over time. The magnitude of this decline is generally less than 10%, but in one case is in excess of 90% - see Appendix A. We do not know the reasons for this decline, or whether it results from calibration drift, or from an underlying decline in the flow of water from the heat pump. If the former, we may have systematically underestimated SPFs.
- unreliable metadata. For example, we have e.g. been unable to trust the schematics that were provided for all of the sites in the trial, and have had in some cases to rely on the monitored data itself to try to establish the precise configuration of some installations. At its simplest, we have monitoring data, but we cannot be absolutely sure in all cases what systems the data describe.

A separate document that will be published in the future will address systematic errors and their effect on results in more depth.

Despite these caveats, we believe that our findings are indicative of the performance of HP systems in the sample. The results, for instance  $SPF_{H4}$  of 2.30 ( $\pm 0.03$ ) and 2.75 ( $\pm 0.09$ ) for ASHPs and GSHPs in the adjusted Sample C, are consistent with previous findings in the EST Phase II field trial and the Preliminary findings, given the different circumstances of those analyses.

---

<sup>3</sup> Frost protection may be provided by adding propylene or ethylene glycol to circulating water. The figure given here applies to ethylene glycol - propylene glycol, which is less toxic and may be more commonly used, would reduce the calibration error to around 4% at a concentration of 25%. Our understanding is that heat meters in the RHPP dataset were not corrected for the effects of antifreeze. Additional work would be needed to confirm the types of antifreeze and their concentrations in use and to refine an estimate of the overall impact on SPF estimates.

The results showed that on average HP systems under UKSET conditions were above the  $SPF_{H2} \geq 2.5$  boundary required for classification as a renewable energy source (mean  $SPF_{H2}$  for ASHP of  $2.56 (\pm 0.03)$  and  $2.92 (\pm 0.09)$  for GSHPs. So while 55% of ASHPs and 79% of the GSHPs can be classified as sources of renewable energy, this still leaves more than one in three ASHPs and one in five GSHPs operating below this key performance threshold and unable to contribute to targets under EU Renewable Energy Directive (European Commission, 2013b)<sup>4</sup>.

Nevertheless the results indicate that >93% of sites already result in carbon savings, even when compared to gas for condensing boilers. In the case of electricity, this report calculates CO<sub>2</sub> savings relative to a marginal carbon factor supplied by DECC of 0.362 kgCO<sub>2</sub>/kWh. Should the grid decarbonise further over the coming decades this will amplify the carbon savings from HP systems (Lowe, 2007; CCC, 2008, 2013; DECC, 2015b; ETI, 2015).

The pattern of savings in fuel costs is more complex, but again the results suggest that the vast majority of sites produce bill savings compared with electricity, coal and LPG, and most produce bill savings with respect to oil. Actions to lift the performance of the lowest 25% to at least that of the current average performance, which should be achievable, would markedly increase the proportion of HP systems that produce fuel cost savings relative to natural gas.

## Next steps

This report has identified a number of avenues for potential further investigation, most of which are at least in part covered under the currently agreed programme of work and will be addressed in the next report examining the reasons for good or poor performance. Specifically:

- Further analytical work to infer the use of electricity to boost heating where this was not directly measured (113 sites). Of these fewer than 30 appear to have some boost heating occurring. This is minor in all but 3 sites.
- An investigation of the progressive decline in the measurement of flow rates for the water circulation in some sites, which may indicate metering or operational problems.
- A number of approaches will be examined to include as many of the over 200 sites that are currently omitted from the analysis, such as resolving some of the sites with apparently mislabelled schematics. Among other things, this may involve identifying practical methods of temperature adjustment of SPF<sub>s</sub> when much less than annual data is available.
- Further investigation of the potential impact of glycol antifreeze on measurement of heat where meters were calibrated for water.

---

<sup>4</sup> European Commission (2013b) states “Electrically driven heat pumps with an SPF of 2.5 and above, as well as thermally driven heat pumps with an SPF of 1.15 and above, should be included. Electrically driven heat pumps with an SPF below 2.5, as well as thermally driven heat pumps with an SPF below 1.15, must be excluded. It is not sufficient to judge if the national average is above this threshold — even if the national average is above this threshold the total capacity should be estimated based on the assessment of this threshold on the level of individual heat pump units.”

This work will be complemented by case studies of approximately 20 sites based on detailed site surveys and occupant interviews. These case studies will, in particular, inform our work on reasons for good and bad performance.



## 1 Introduction

This technical output presents the findings from detailed analysis by RAPID-HPC using data collected on heat pump (HP) systems and their operation in the residential sector in a monitoring project under the Renewable Heat Premium Payment (RHPP) grant scheme. The present technical output builds on previous analysis, and forms part of a larger programme of work that was initiated in December 2014 with forthcoming publications outlined in Table 1-1. This report presents a summary of some key analytical outputs which have been produced to date including the following key advances on previous work: the adjustment of data to standard temperature conditions for quantifying the performance of HPS, seasonal variations in performance, and variations in load factors. It should also be noted that content of this technical output is aimed at readers with a background in energy policy, and/or heating system technology.

**Table 1-1. Forthcoming publications**

Output	Title & description
1	<b>Reasons for good/bad performance:</b> investigation of the factors that affect performance
2	<b>Case studies results &amp; analysis:</b> socio-technical investigations of approximately 20 individual sites to identify and illustrate specific issues and their impact on HP system performance

The RHPP Scheme was introduced by DECC in August 2011 to support domestic renewable heating measures such as air and ground source heat pumps as well as biomass boilers and solar thermal. The scheme closed on 31<sup>st</sup> March 2014. Just over 700 sites, or approximately 5% of the HP systems installed via the RHPP scheme (DECC 2015b) were monitored by the Building Research Establishment (BRE) and the Energy Savings Trust (EST) on behalf of DECC and of these, data for 699 sites were provided to RAPID-HPC. These sites were located throughout GB; 328 properties were Registered Social Housing and the remainder were owner-occupied properties. The sample covered a range of dwelling construction types, sizes, ages and households.

This monitoring campaign has provided the foundation for empirical evidence aimed at informing renewable heat policy development to improve system performance. A more detailed description of the RHPP monitoring programme and its implementation has been presented in the 'Preliminary report on the Renewable Heat Premium Payment metering programme' (Wickins, 2014).

This technical output builds on previous work that includes pre-processing and error detection methods that have been applied to the data and then sets out the basis for exclusion of sites from the analysis dataset based on a combination of missing data and metering issues (this earlier work will be described in detail in the final report from this project). These tools and methods have been developed and extended by RAPID-HPC, informed by tools developed earlier by Wickins and colleagues, during the process of preparing the preliminary report (Wickins, 2014). The tools, methods and results from RAPID-HPC's work have been subject to review and quality assurance both within the consortium and a spot check of software tools has been undertaken by independent experts.

The aim of this output is to obtain the most up-to-date picture of the overall performance of HP systems in the RHPP sample, primarily from the distribution of Seasonal Performance Factors (SPFs) at various system boundaries, including the extent of renewable energy generation. In addition, it provides estimates of expected carbon savings and energy cost savings of these HP systems in comparison with the use of other fuels, as well as some statistics on specific characteristics of HP system operations. Unlike an intervention study or the study of a small sample of exemplars, the aim of this analysis of field trial data is to estimate 'real-world' *in situ* performance of a broad sample of HPs over an extended time period that covers a variety of operational and environmental conditions. The study differs from the previous EST field trial: the RHPP field trial has a larger sample size, but unlike the EST trial, does not involve interventions at underperforming sites (DECC, 2013a). The RHPP trial has also taken place roughly three years later than the preceding EST trial, during which time the Microgeneration Certification Scheme (MCS) installation standards (MCS MIS 3005) and associated training programmes have been improved. With the monitoring carried out over a period of roughly two years, this current output also goes beyond the preliminary findings from the RHPP trial (DECC 2014 Preliminary data from the RHPP heat pump metering programme), which attempted to evaluate the performance of the sample *from a single winter month of data*, rather than determining SPFs from annual data.

There are two key aspects of the work presented in this report:

- The selection of two large samples of sites for analysis that had sufficient data quality needed for calculation of SPFs at various system boundaries, which measure *the annual efficiency* of the HP system according to an established methodology developed across Europe (Riviere et al. 2011). Since the use of SPFs requires sufficient reliable monitoring data across at least one complete year, the sample and data selection process addresses such issues as missing data and extended periods when the HP system is unused (possibly due to the dwelling being unoccupied for a period).
- The adjustment of the results to a set of standard external weather conditions, referred to as the UK Standard External Temperature (UKSET) and chosen to match temperatures used in the Standard Assessment Procedure (SAP) as closely as possible. The resultant adjusted data have been used for much of the subsequent analysis to obtain aggregate statistics, which are

independent of the particular weather conditions obtained during the RHPP trial data gathering phase.

The UKSET conditions used were defined according to 10-years (1998-2007) of hourly weather station data from Grantham, Lincolnshire, that were found to provide the closest match to data for the East Pennines used in SAP. As is explained in the main body of this work, adjustment for other weather variables (such as wind speed) were included in a two-stage regression model, but external temperature was found to be the significant predictive factor needed for the standardisation process.

While some descriptive statistics of the HP systems are presented as part of this current analysis, the investigations remain on-going. Appendix A to this output provides a summary of our approach to sample selection algorithms and adjustment to UKSET.

All results presented should be caveated, however, in the light of potential systematic errors such as the effect of glycol (where it is uncertain as to the extent this was used) on heat meters calibrated for water. Subsequent outputs will delve further into such matters and into the performance level of specific sites or groups of HP sites, particularly those with markedly high or low efficiency levels.

## 2 Methodology

Previous work of RAPID-HPC has documented the progressive development of methods for assessment and analysis of the RHPP HP datasets. These involve investigation of the *monitored data*, which contains records at two minute intervals recorded by the ensemble of loggers installed at each of the 699 sites provided by DECC; combined with cross-checking of available *metadata* which summarises each site and the corresponding HP specification, the Microgeneration Certification Scheme (MCS) certificate, installation checklists, incident logs and other documentation.

Broadly, the assessment has progressed through a series of stages, as described below.

- 1 Datasets were processed into a single time-series dataset for each site, identifying the start and end dates and the extent of missing or clearly invalid (implausible or outlier) data and cross-checking with the metadata for correspondence, such as between the labelling of recorded data and the schematic for the specified HP system.
- 2 Checks were undertaken on the relationships between the various parameters to ensure internal consistency, which otherwise might point to errors such as faulty logger operation or misidentification of loggers.
- 3 Sensitivity analyses were conducted for the likely impact on key findings of varying amounts randomly missing data (as well as for periods of continuously missing data with varying durations) and of changes in the criteria applied for the inclusion of sites for subsequent analysis based on their data quality.

This section provides a brief outline of the sample selection process and subsequent calculation methods for the various analyses.

### 2.1 Sites included in analysis

Detailed monitoring of HPs performance is demanding from both a practical and methodological perspective, as the study requires numerous sensors in a range of configurations (categorised under a specific *schematic*) to suit the diverse systems and physical settings of each installation site. The sensors need to provide accurate high frequency data (in this case at two minute intervals) for at least 12 months, even if there are gaps in monitoring within this period.

Of the total 699 sites in the RHPP sample supplied, 99 sites were temporarily excluded at the outset of the project due to technical issues relating to the installation of water temperature sensors. A further 104 sites were omitted due to missing data streams needed for the calculation of SPFs, or where the correct

schematic used could not be resolved in a way that permitted calculation of SPFs. It is hoped that the majority of sites in these groups can be included in at least some aspects of future analysis.

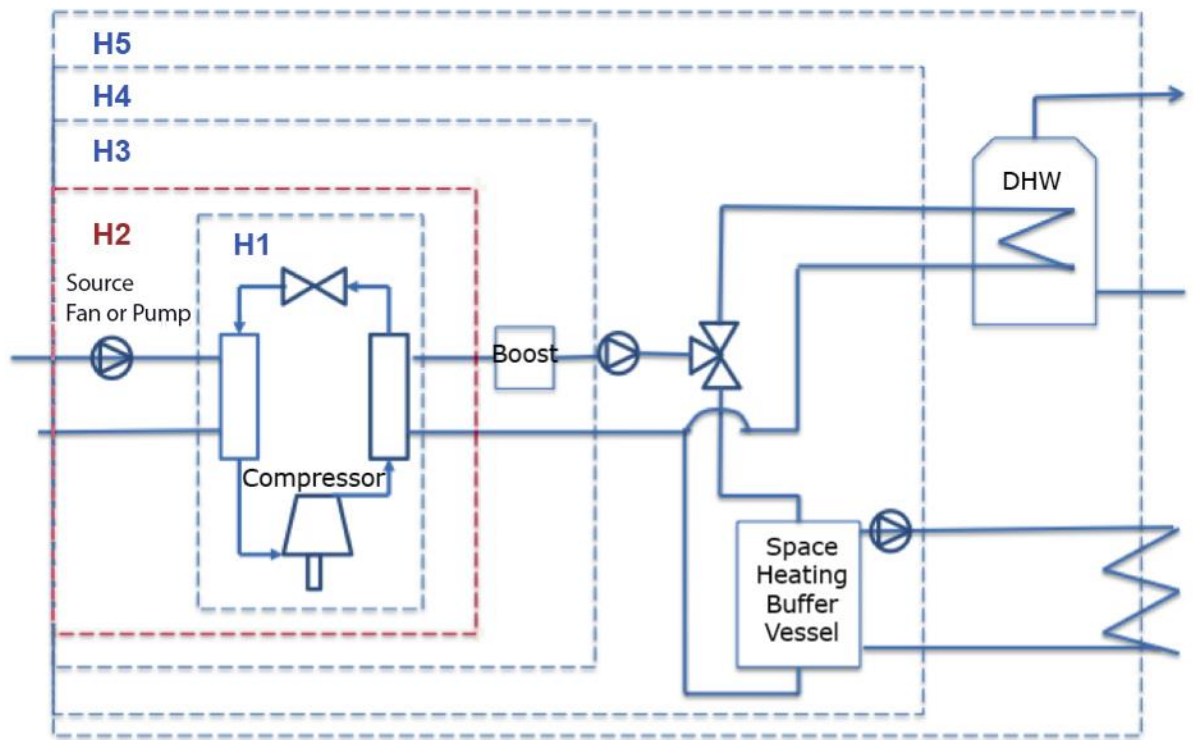
The RHPP sample available for consideration in this analysis, therefore, comprised 496 sites with the overall data collection spanning more than three years, from November 2011 to March 2015, where the initial stage of the field trial involved a steady ramp up of sites as HP systems and the meters for monitoring data were installed. A series of checks and filters were then applied to select two samples:

- **Sample B (Broad) with 391 sites** (297 ASHP and 94 GSHPs) with sufficiently complete and stable monitoring data of the HP system over a year to enable calculation of the SPFs. Specifically:
  - at least one monitoring period of 13 consecutive months where heat output and electricity input were recorded concurrently at some time on each of at least 5 days in each month;
  - where more than one such monitoring period is available, the 13 consecutive months of data was selected with the minimum difference in water circulation flow rate between the 1<sup>st</sup> and 13<sup>th</sup> month (indicative of stable performance of meters and or the HP system over the period);
  - the calculation is based on the last 12 months of the 13 months of data selected.
- **Sample C (Concurrent data) with 299 sites** (223 ASHP and 76 GSHPs) is a subset of sites in Sample B used for adjustment of data to calculate the SPFs under UKSET conditions.
  - monitoring data streams available to calculate  $SPF_{H4}$  and  $SPF_{H2}$  for *the same annual period* of 1/11/2013 and 31/10/2014.
  - Spells of missing data must be less than 30 minutes (i.e. missing data occurring at  $\leq 14$  consecutive time points, with each time point at two minute intervals)
  - The cumulative missing data (across all variables needed for SPFs) must amount to  $\leq 70\%$  of the total annual measurement period (equivalent to  $\leq 250$  days out of 365 days).

In summary, the large size of Sample B reflects the broad and inclusive selection criteria applied. It allows for sites with data that may contain substantial monitoring gaps, for instance due to the occupants being away and switching the HP system off for a number of weeks. For each site, data are selected on the basis of the most stable metering and HP system operation over the year according to the water circulation data. Sample C is more restrictive, requiring all sites to have data from the same 12 month period, that are then subject to adjustment from actual, relatively warm winters in the monitored data, to UKSET conditions. (Note while sites in Sample C represent a subset of Sample B, the specified period of concurrent data may not be the same annual data that was selected for analysis under the completeness and stability criteria of Sample B.)

## 2.2 System boundaries and monitored data parameters

HP system boundaries are fundamental to the evaluation of annual HP performance using monitored data, with specific parameters  $SPF_{H1}$ ,  $SPF_{H2}$ ,  $SPF_{H3}$  and  $SPF_{H4}$  explained and applied in previous work reporting on the SEPEMO project (Riviere et al., 2011) and the second phase of EST's HP field trial (Dunbabin et al., 2013). The significance of using different system boundaries has also been discussed in previous literature, for instance on a field trial of HP systems in Germany analysed by a team at the Fraunhofer ISE Institute (Miara et al., 2011), and by Gleeson and Lowe, (2013).



**Figure 2-1. SEPEMO system boundaries (derived from Riviere et al., 2011) with the addition of H5 boundary that accounts for heat losses from the hot water cylinder**

The SEPEMO methodology (Figure 2-1) starts from the HP only ( $SPF_{H1}$ ), with expanding boundaries covering the supply air fan or ground loop pump power into the HP ( $SPF_{H2}$ ), backup heaters, including electric immersion for domestic hot water if present ( $SPF_{H3}$ ) and finally, system circulators or pumps ( $SPF_{H4}$ ). Note the relationship between the higher index number and lower numerical value for SPF for the same installation.

The simplicity of the SEPEMO method and its applicability to estimating the renewable heat from HP systems of various types, as well as the need for standard approaches for performance indicators has resulted in its adoption across Europe. Notably, for the purposes of estimating the amount of renewable energy generated by heat pumps for the EU Renewable Energy Directive, the EU Commission Decision of 1<sup>st</sup> March 2013 defines the relevant measure of efficiency to be  $SPF_{H2}$ , i.e. the efficiency of the heat

pump without the inclusion of electricity used for backup or distribution circulation pumps. The Directive considers heat pumps can be categorised as providing renewable energy provided that  $SPFH2 \geq 2.5$ .

**Table 2-1. The complete set of parameters included in the monitored data**

Parameter	Description
<b>Eb</b>	Electricity meter for whole system boost only
<b>Edhw</b>	Electricity meter for domestic hot water (typically an immersion heater)
<b>Ehp</b>	Electricity meter for the HP unit (may include a booster heater and circulation pump)
<b>Esp</b>	Electricity meter for boost to space heating only
<b>Fhp</b>	Flow rate of water from HP (may be space heating only)
<b>Fhw</b>	Flow rate of water to DHW cylinder
<b>Hhp</b>	Heat meter from HP (may be space heating only)
<b>Hhw</b>	Heat meter to DHW cylinder
<b>Tco</b>	Temperature of refrigerant leaving the condenser
<b>Tin</b>	For ASHP: Temperature of refrigerant leaving the evaporator For GSHP: Temperature of ground loop water into the HP
<b>Tsf</b>	Flow temperature of water to space heating
<b>Twf</b>	Flow temperature of water to cylinder

Table 2-1 shows the complete set of parameters in the monitored data used to calculate the SPFs, though it should be noted that different sites had different combinations of parameters according to the schematic (or monitoring layout) that was applicable to that installation and plumbing arrangement.

However a set of four temperature variables are obtained ( $T_{co}$ ,  $T_{in}$ ,  $T_{sf}$  and  $T_{wf}$ ) for all sites. Figure 2-2 and Figure 2-3 provide examples of two simple schematic diagrams (for an air source and ground source HP) that illustrate the location of monitoring points corresponding to the monitored parameters in any given heat pump system. Full details of the monitoring programme, including the overall monitoring philosophy and considerations of sensor resolution, can be found in the Preliminary Assessment report (Wickins, 2014); a summary of this report will be published at the end of the project.

Schematic 2.4  
Air-source system providing SH and DHW

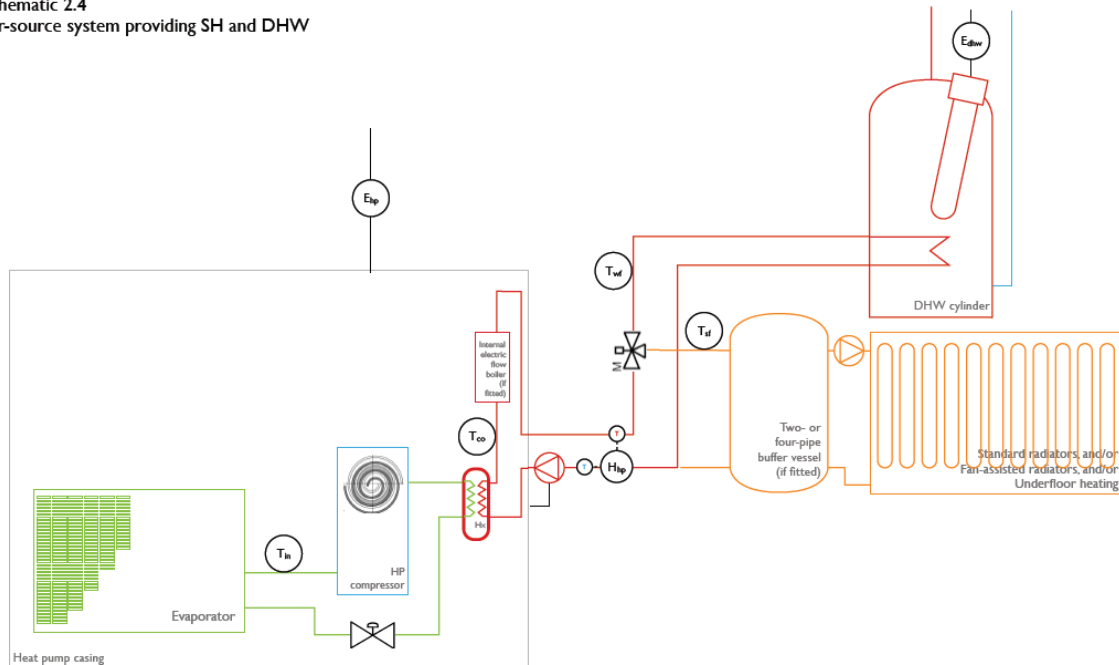


Figure 2-2. An example simplified schematic of the metering arrangement for a monobloc ASHP that provides heat to space heating and a domestic hot water cylinder with an immersion element.

Schematic 16.12  
Ground-source system providing SH and DHW

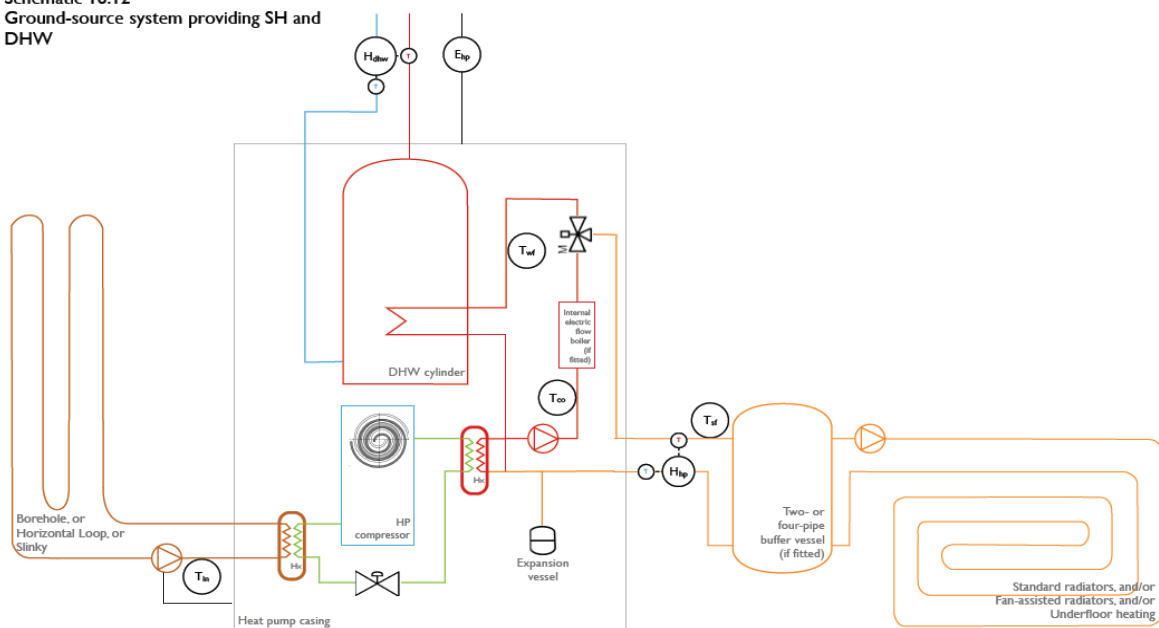


Figure 2-3. An example of a GSHP with an integrated domestic hot water cylinder



## 2.3 Calculating performance at the SEPEMO system boundaries

### System Boundary H4 and H5

For the majority of sites, the performance at system boundary H4 is available directly from the measurements. The heat output is equal to the sum of  $H_{hp}$ ,  $E_{dhw}$  and  $E_{sp}$  (as the immersion heater and space heating only boost heater (if present) are downstream of the heat meter and so their heat output must be added on, we assume that all electric heaters operate with 100% efficiency). The electrical consumption is equal to the sum of  $E_{hp}$ ,  $E_b$ ,  $E_{sp}$  and  $E_{dhw}$  (as appropriate for the meters installed at the site).

For most sites, the circulation pump is located upstream of the heat meter, so that any heat it adds to the circulating fluid is included in  $H_{hp}$ , and its electricity consumption is included in  $E_{hp}$ . (Note that in most cases most or all of the electricity consumption by circulation pumps will appear as heat in the dwelling.) For some sites one or both of these conditions are not true and the summations must be adjusted accordingly.

The H5 System Boundary, as shown by the outer dotted boundary in Figure 2.1, is not defined by SEPEMO. Instead, it emerged as an extension of the SEPEMO boundary approach (Gleeson & Lowe, 2013 : 641). Performance based on tapped hot water rather than heat flow into the cylinder, was originally defined as “System efficiency” in the Phase I report of the EST HP Field Trials (Dunbabin & Wickins, 2012).

The calculation for what has since been redefined as  $SPF_{H5}$  is, therefore, the same as for the H4 boundary, except that it accounts for losses from the hot water cylinder. To enable a comparison with the EST results, this analysis has adopted the same basic assumption as in the Preliminary Assessment report of assuming hot water cylinder losses are 30% of the total heat input into the hot water cylinder (Wickins, 2014). But we note that the relationship between heat loss and hot water drawn from the cylinder is in principle complex, and the assumption of a simple proportional relationship may not be correct.

### System Boundary H3

To calculate the performance at system boundary H3, the electricity use of the circulation pump and the heat that it adds to the heating fluid must be subtracted. Neither heat nor electricity are measured directly and some assumption must be made. The power rating of the circulation pumps has been recorded as part of the monitoring equipment installation, however as discussed in previous preliminary work for DECC this information is not considered to be reliable. Typical circulation pump power ratings are expected to be in the range 30-100W and the Preliminary Assessment (Wickins, 2014) attempted to estimate this from the monitored data. Unfortunately the resolution of the electricity meter data is only to 1Wh per two minutes, equivalent to a continuous 30W load, so the pump power consumption is of the same order as the sensor resolution over this period. RAPID-HPC have therefore made the assumption that the pump rated power divided by the design flow rate is equal to 280W/kg/s, where the design mass flow rate is estimated as the 95<sup>th</sup> percentile of the flow rates observed in the monitored data. This results

in a pump rated power of 70W for a system with an estimated design mass flow rate of 0.25kg/s. This possibly errs on the high side for modern pumps.

With the introduction in 2013 of increasingly stringent energy standards for circulation pumps through ECO design guidelines (European Commission, 2009b), power consumption of new circulation pumps is likely to decrease significantly as installers move to variable speed control. The effect of circulation pumps on  $SPF_{H4}$  should therefore become less important over time, and the difference between  $SPF_{H4}$  and  $SPF_{H3}$  for any given installation will decline. In practice however, it is noted by those involved with field trials that constant operation of the circulation pump, regardless of heat load, is not an isolated phenomenon.

The circulation pump power consumption at each time step is then calculated as the rated power multiplied by the flow rate at that time step divided by the estimated design flow rate, i.e. the rated power consumption is scaled down linearly with measured flow rate. In reality, in the case of a variable speed pump the power consumption varies with the cube of mass flow rate, however the exact operation level is not easy to ascertain, for instance when half of the design flow rate is recorded, if this is due to the pump operating at half speed for the entire time period or operating at full speed for half of the time period.

The pump electricity consumption is subtracted from the electricity consumption at boundary H4. It is assumed that all of the pump electricity consumption is converted to heat in the circulating fluid and this is subtracted from the heat output at boundary H4. In practice some fraction of this heat may be transferred directly to the air inside the dwelling, rather than the circulating fluid.

## System boundary H2

To obtain the performance at system boundary H2, the electricity use of and heat output of backup heaters is subtracted from the H3 values. In all cases we assume that the heat output from backup heaters is equal to the electricity input.

For some of the monitored systems, the electrical consumption of inline booster heaters has not been directly monitored (in some cases heaters are built in to sealed HP units). Initially it was intended that the temperature sensors  $T_{co}$ ,  $T_{wf}$  and  $T_{sf}$  would be used to estimate the heat input by an unmetered booster heater, however as is detailed in Appendix B, in many cases there appear to be constant offsets between the temperature sensors, making such estimation problematic. An alternative approach may be to derive booster heater operation from the HP overall electricity consumption  $E_{hp}$ ; however a reliable algorithm for automatically detecting these events has not yet been developed.

We note that in future HP monitoring studies it might be beneficial to record the HP power factor, as a booster heater switching on should change this noticeably - an electric resistance heater will have a power

factor of around 1, a compressor may have a power factor as low as 0.4<sup>5</sup>. The combination of a resistance heater and a compressor with the same power rating would then have a power factor of around 0.66.

## 2.4 Adjustment to standard weather conditions

The objective of adjusting the monitored data to a standard set of weather conditions is so that, for example, results from differing weather regions across the UK can be compared, and specifically, to remove the impact of the warmer than average winter that occurred during the monitoring period. In this report, the monitored data is adjusted to the 10 year (1998-2007) mean temperature observed in the East Pennines as this is the area for weather data used in SAP. Since the exact location used to derive the SAP data is unknown, however, weather data from Grantham, Lincolnshire over the 10 year period has been selected, as this was found to have monthly mean values close to those specified in SAP.

External weather conditions were not monitored as part of the RHPP data collection. Therefore data has been obtained from the United States National Centres for Environmental Prediction (NCEP) Climate Forecast System Reanalysis (<http://cfs.ncep.noaa.gov/cfsr/>) (Saha et al., 2011). This weather dataset has been shown to be as accurate as any historic weather dataset while providing a higher geographical resolution with no missing data (Sharp et al., 2015; Fuka et al., 2014).

Although previous work carried out for the EST phase II report found a good correlation between weekly heat demand and weekly degree days (Dunbabin et al., 2013), the purpose here is to generate a model for heat output and electricity consumption at higher resolution to allow for the potential impact of factors other than external temperature, including wind speed and insolation. As the description below reveals, it turns out that external temperature is the only significant factor needed, hence naming the process as adjustment as under UK standard external temperature (UKSET) conditions. Despite the simplicity of the final correction process, it was useful to show that weather factors other than temperature were not needed for the adjustment. More broadly, this work determines the background for possible future development of a simpler model for adjustment of SPFs, and even more usefully, for estimation of annual performance when only a few months of data are available.

The monitored heat output and electricity consumption at each system boundary (H2, H3, H4) is weather corrected separately and the resulting values used to calculate SPFs (SPFs cannot be directly weather corrected as they would need to be weighted by heat demand). A two-part, regression-based correction method is used, first estimating heat output as a function of external temperature, time of day, and the previous day's mean external temperature. A second regression then estimates electricity consumption as a function of heat output and external temperature. The first model for heat output therefore captures the complex of interactions between external weather (primarily temperature), building fabric, heating system controls and dynamics and occupant behaviour that give rise to heat demand; and the second captures the

---

<sup>5</sup> In practice, power factors will depend on the type of motor, on motor control electronics, and on loading. But the precise numbers are less important than the principle.

physical relationship between that demand and electricity consumption, which depends in part on external temperature.

Both the heat output and electricity consumption models are estimated separately at each site for each system boundary, split by hot water and space heating use. The heat output model for each site is then run using the ten years of observed temperature, yielding heat output predictions that are entered into the electricity consumption model. The resulting predictions are summed at each time point and divided by ten to give the ‘average year’ for heat output and electricity consumption at each site, separated by system boundary and use (hot water or space heating).

It should be noted that while the monitoring data is recorded at two-minute intervals, the models are estimated at hourly time intervals so as to match the weather data. The monitored heat output and electricity consumption data were therefore aggregated to hourly time intervals. For each hour, the mean of the two-minute intervals was calculated and multiplied by 30 to reach an hourly average. Hours with fewer than 15 half-hourly observations are excluded from the analysis as unreliable.

The regression approach overcomes a major problem encountered with the binning approach for hourly data used in initial analyses. The binning approach led to prediction estimates for each given temperature that were biased downward due to a high number of zero values. These were due to the relationship between heat demand and time of day – often the coldest hours occur at night, when the HP is switched off. There are also data during the day when the HP is switched off while people are away from dwelling, which show as zero (i.e. the HP system is not running) despite the external conditions.

Several approaches were considered for modelling this phenomenon, and the model used in this report uses a regression specification that includes time of day variables *and their interaction* with external temperature. What this means is that the effect of external temperature on heat demand depends on the time of day.

In order to determine the correct specification for the regression equations, a ‘*k*-fold cross-validation’ approach was used (Refaeilzadeh et al. 2009). This process splits the data into *k* separate folds (or subsamples), in this case five, and leaves one fold out for the estimation process. The model is then used to predict the values of the final fold, giving an ‘out-of-sample’ prediction criterion. Root mean squared error (RMSE) is a standard out-of-sample criterion. That is, if the vector of observed heat demand is  $\theta$  and the predicted values of heat demand are represented as  $\hat{\theta}$ , then (where E is the expectation operator, representing the mean):

$$RMSE = \sqrt{E[(\hat{\theta} - \theta)^2]}$$

The model that minimised the RMSE was selected as its predictive performance was the most important criterion. Importantly, this avoids over-fitting to the data since the model is tested against data not used to fit its parameters (i.e. in the final fold). Where RMSE improvements were not greater than the standard

deviation of the RMSE, additional terms were excluded. Importantly, this is why wind speed was excluded from the model, as it did not provide a significant RMSE improvement and hence did not significantly improve the model.

The final regression equation for heat output uses ordinary least squares (OLS) to estimate a model specified with external temperature,  $T_{ex}$ , along with the square and cube of the external temperature. These terms allow the model to represent non-linearities in the data and underlying processes. The cubic specification minimises the RMSE as well as accommodating the theoretical shape of the curve, that of a backward 's' shape. Each of the original temperature levels, its quadratic term, and its cubic term were interacted with 24 dummy variables which represented hours of the day. Each of these dummy variables were also included in the model on their own. For electricity consumption, the model is formed from  $T_{ex}$ ,  $T_{ex}^2$ , and  $T_{ex}^3$ , *heat output* and all the interaction terms,  $T_{ex} * \text{heat output}$ ,  $T_{ex}^2 * \text{heat output}$  and  $T_{ex}^3 * \text{heat output}$ . This means that the relationship between heat output and electricity consumption depends on the given site characteristics mediated by external temperature.

## 2.5 Performance of alternative technologies

One of the key outputs from this analysis is an indication of whether HPs can be expected to produce savings in fuel bills or carbon emissions against an alternative heating system. To address this question, it is necessary to know or to make assumptions about the performance of the alternative heating systems. In the RHPP dataset it is not possible to establish for certain what technology was replaced by the HPs. The fuel that was in use before the HP was installed is available for privately owned dwellings, but for social landlord owned dwellings it is provided only in aggregate across all sites owned by that landlord for which heat pumps have been installed via the RHPP. In the results section, Table 3-6 gives an indication of the extent that HP systems installed via the RHPP scheme have replaced other fuels.

This report adopts the approach used in the Preliminary Assessment report of using reasonable assumed efficiencies for new systems of various technologies together with assumed fuel price and carbon intensity values to derive SPFs which a HP must exceed in order to outperform that particular technology. For a truly fair comparison to be made, the system components included in each system should be comparable. When looking at fuel bill savings and carbon reductions, what matters is the total performance of the entire system, so for HPs we select  $SPF_{H4}$  as the figure for comparison. A gas boiler heating system also requires electricity, primarily to run its circulation pump but also to meet various other parasitic loads in the boiler itself, for example flue fans, control systems, ignition systems, and so on. However, the electricity consumption of a gas boiler heating system is very small compared to its gas consumption: SAP 2012 assumes that a heating system circulation pump requires 130kWh per year of electricity and a boiler flue fan 45 kWh per year, giving a power to heat ratio in the region of 1.3%. In addition, combi-boilers can have an electric keep-hot facility which can consume 600-900 kWh per year of electricity (BRE,

2013); this would dwarf the other parasitics, but we have assumed here that the comparison is with the performance of a regular boiler with a domestic hot water tank).

The cost of 175 kWh of electricity would be around £25 depending on the exact electricity price assumed. This is relatively small compared to the UK typical gas household bill, which is in the region of £750 (DECC, 2015a). Hence, we adopt the approach of the Preliminary Assessment of omitting the parasitic electrical loads of the alternative technologies, though we acknowledge that this gives non-HP systems a small advantage.

As in the Preliminary Assessment, two scenarios are considered: one where heat output is the same for HPs and alternative technologies, and one where heat output is 10% higher for the HP. As explained in the Preliminary Assessment report (Wickins, 2014):

*Consideration that heating energy demand may increase after installation of a HP is in response to the EST HP field trial [...], which noticed that average internal temperatures were, on average, 1°C higher than in EST's condensing boiler field trial [...]. Consideration of degree days shows that a 1°C increase in internal temperature puts up space heating energy demand by approximately 10%.*

**Table 2-2. Carbon intensities and fuel costs used to determine the SPF<sub>H4</sub> of an HP system (on standard tariff electricity) needed in order to outperform other fuels**

Fuel <sup>a</sup>	Carbon intensity (gCO <sub>2</sub> /kWh)	Fuel cost (p/kWh)	System efficiency	SPF needed for reduction in CO <sub>2</sub> emissions	SPF needed for fuel cost reduction
<b>LPG</b>	215 <sup>b</sup>	8.32 <sup>c</sup>	85%	1.43	1.54
<b>Electricity (economy 7)</b>	362 <sup>b,d</sup>	7.89 <sup>e,f</sup>	100%	1.00	1.91
<b>Oil</b>	247 <sup>b</sup>	5.80 <sup>b,f</sup>	84%	1.23	2.19
<b>Coal</b>	344 <sup>b</sup>	5.30 <sup>b,f</sup>	60%	0.63	1.71
<b>Gas</b>	185 <sup>b</sup>	4.80 <sup>b,f</sup>	85%	1.66	2.67
<b>Electricity (standard)</b>	362 <sup>b,d</sup>	15.10 <sup>b,f</sup>	100%	1.00	1.00

<sup>a</sup> Selected fuels potentially displaced by HP systems (using electricity on the standard tariff), where gas is included only as an indicator of the current best performer among non-renewable fuels. Thermal efficiency of gas and lpg boilers has been taken from EST's Condensing Boiler Field Trial (Gastec, 2009). Efficiencies for coal and oil boilers have been taken from SAP (BRE, 2013).

<sup>b</sup> Source: Green Book supplementary guidance: valuation of energy use and greenhouse gas emissions for appraisal, DECC, last updated 2<sup>nd</sup> October 2014.

<sup>c</sup> Source: <http://www.energysavingtrust.org.uk/domestic/content/our-calculations> – February 2015

<sup>d</sup> Note this is an indicative marginal value, not a grid average, which is significantly higher - see DECC (2015b). The figure of 0.362 provided by DECC is the mean marginal factor for the four year period 2011-2014 (see accompanying Data\_tables\_1-20\_supporting\_the\_toolkit\_and\_the\_guidance.xlsx). This document suggests a continuous decline in carbon intensity for grid electricity over the coming decades, and a convergence of marginal and average values. The marginal intensity is indicated to fall to 0.282 in 2020 and to 0.129 g(CO<sub>2</sub>)/kWh in 2030.

<sup>e</sup> Source: Average variable unit costs and fixed costs for electricity for selected towns and cities in the UK, DECC, last updated 26<sup>th</sup> March 2015, table 2.2.4, night price 6.48p/kWh, day price: 15.88 p/kWh, percentage used at day rate: 15%, based on SAP 2012 table 11.

<sup>f</sup> 2011-2014 mean.

In compiling the above table, we have used updated figures for fuel prices and carbon intensities provided by DECC as needed, with more details on the sources given in the annotations to the table. Note that the above table is based on a marginal carbon factor for electricity rather than the current grid average as used in the Preliminary Assessment. The marginal factor may be more appropriate for the evaluation of a new technology that is being introduced at a relatively low initial rate. If the carbon intensity for electricity continues to fall, this will further increase the carbon savings from heat pumps.

For the scenario where the space heat output is assumed to increase by 10% for HPs the breakeven SPFs are correspondingly higher.

Table 2-2 provides an indication of the  $SPF_{H4}$  needed for HP systems either to result in  $CO_2$  emissions reductions (based on current carbon intensities of each fuel) or in annual fuel cost reductions (based on recent fuel prices). Note that the RHPP scheme is not aimed at the use of HP systems to displace gas condensing boilers, rather this fuel has been included because of its dominance in the UK domestic sector and as a benchmark for the current best performer in terms of both  $CO_2$  emissions and fuel costs among the non-renewable alternatives to heat pumps (Palmer & Cooper, 2013). Even at the given marginal carbon intensity for electricity, the  $SPF_{H4}$  needed to reduce  $CO_2$  emissions is less than 1.5 for all fuels except gas (where the  $SPF_{H4}$  breakeven point is 1.66). The performance requirements to result in fuel cost reductions are somewhat more demanding, though the only fuels that require a breakeven  $SPF_{H4}$  over 2.0 are oil (2.19) and gas (2.67).



### 3 Results

#### 3.1 Seasonal Performance Factors

Table 3-1 summarises findings for mean SPF<sub>F</sub>s for Sample B and Sample C, with the latter also showing the performance estimates after adjustment to UKSET conditions. First, even though the selection criteria for Sample B allowed for the inclusion of sites with a considerable degree of missing data and with different annual periods for the evaluation, no statistical difference is evident in the mean SPF<sub>F</sub>s across the various system boundaries compared with SPF<sub>F</sub>s estimated for Sample C. GSHPs in the sample showed consistently higher mean performance than ASHPs, for instance  $2.75 \pm 0.07$  and  $2.35 \pm 0.04$  respectively for the mean SPF<sub>F4</sub> of Sample B. More generally, the expected pattern of decline for the mean SPF<sub>F</sub>s is evident as the system boundaries are widened, with SPF<sub>F2</sub> recording the lowest performance. (SPF<sub>F5</sub> was calculated based on an assumed 30% heat loss from the hot water cylinder.)

**Table 3-1. Mean SPF<sub>F</sub>s for HP systems in Sample B, Sample C unadjusted, and Sample C adjusted to UKSET conditions**

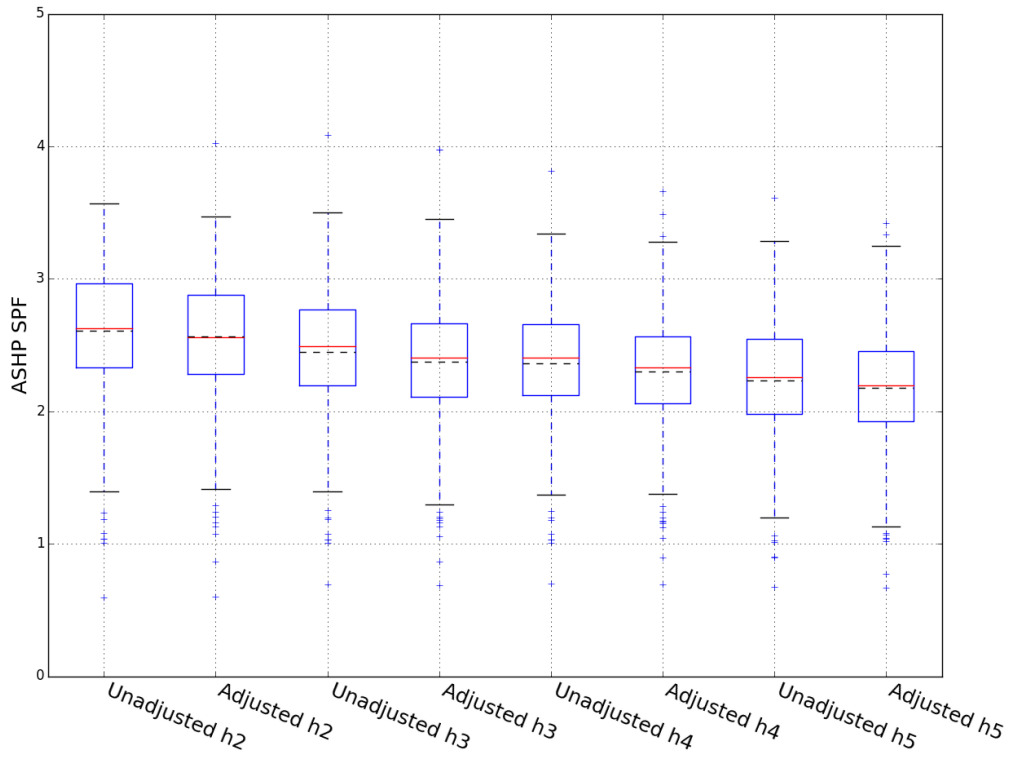
SPF	HP type	Sample B		Sample C		UKSET adjusted
		N	Mean ( $\pm$ Std. Error)	N	Mean ( $\pm$ Std. Error)	Mean ( $\pm$ Std. Error)
SPF <sub>F2</sub>	ASHP	297	2.59 ( $\pm 0.04$ )	223	2.61 ( $\pm 0.04$ )	2.56 ( $\pm 0.04$ )
	GSHP	94	2.91 ( $\pm 0.08$ )	76	2.93 ( $\pm 0.10$ )	2.92 ( $\pm 0.10$ )
SPF <sub>F3</sub>	ASHP	297	2.44 ( $\pm 0.04$ )	223	2.44 ( $\pm 0.03$ )	2.38 ( $\pm 0.03$ )
	GSHP	94	2.90 ( $\pm 0.08$ )	76	2.92 ( $\pm 0.10$ )	2.91 ( $\pm 0.10$ )
SPF <sub>F4</sub>	ASHP	297	2.36 ( $\pm 0.04$ )	223	2.36 ( $\pm 0.03$ )	2.30 ( $\pm 0.03$ )
	GSHP	94	2.75 ( $\pm 0.07$ )	76	2.76 ( $\pm 0.09$ )	2.75 ( $\pm 0.09$ )
SPF <sub>F5</sub>	ASHP	297	2.23 ( $\pm 0.04$ )	223	2.23 ( $\pm 0.03$ )	2.18 ( $\pm 0.03$ )
	GSHP	94	2.51 ( $\pm 0.07$ )	76	2.49 ( $\pm 0.08$ )	2.48 ( $\pm 0.08$ )

**Table 3-2. Estimated SPF<sub>F</sub>s for ASHPs and GSHPs using weather corrected data**

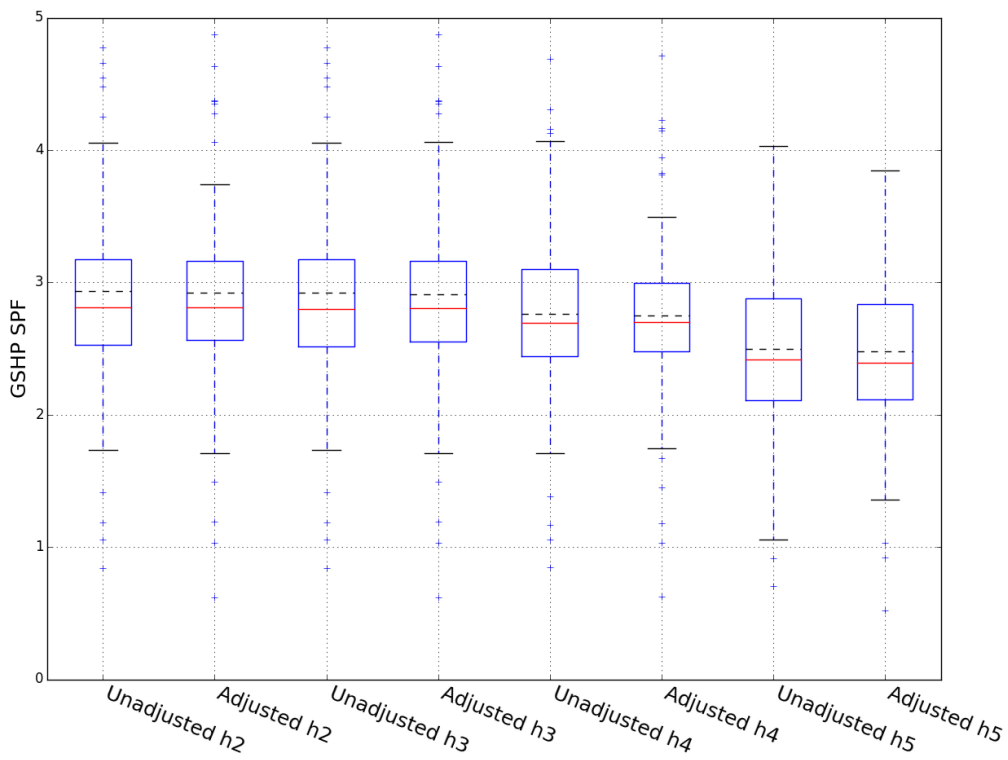
System boundary	HP type	N	Mean (SD)	Median (IQR)
<b>SPF H2</b>	ASHP	223	2.56 (0.61)	2.56 (2.28 - 2.88)
	GSHP	76	2.92 (0.85)	2.81 (2.57 - 3.16)
<b>SPF H3</b>	ASHP	223	2.38 (0.5)	2.4 (2.11 - 2.67)
	GSHP	76	2.91 (0.86)	2.80 (2.55 - 3.16)
<b>SPF H4</b>	ASHP	223	2.30 (0.47)	2.33 (2.06 - 2.56)
	GSHP	76	2.75 (0.75)	2.70 (2.48 - 2.99)
<b>SPF H5</b>	ASHP	223	2.18 (0.46)	2.2 (1.92 - 2.46)
	GSHP	76	2.48 (0.7)	2.39 (2.12 - 2.84)

The mean SPF<sub>F</sub>s for GSHPs for Sample C obtained under UKSET conditions were the same within the statistical uncertainty as the unadjusted values, while for the ASHPs (the performance of which are expected to be more sensitive to external temperatures) the adjusted SPF<sub>F</sub>s tended to be slightly lower (by less than 3%). For instance the SPF<sub>H4</sub> for ASHPs declined from 2.36±0.03 to 2.30±0.03, though such results individually are not statistically different. Further the distribution of SPF<sub>F</sub>s for Sample C are essentially unchanged after adjustment to UKSET conditions, while it is also worth noting that in both cases the median and mean SPF<sub>F</sub>s are similar for ASHPs (Figure 3-1), whereas the distributions tended to be skewed for GSHPs (Figure 3-2) with the median SPF<sub>F</sub>s generally higher than the mean values. Appendix A provides individual histograms showing the distributions for SPF<sub>H2</sub> and SPF<sub>H4</sub> in more detail (Figures A-6 to A-9). We note however that it is possible that the performance particularly of ASHPs would decline more rapidly in very severe weather. Our dataset included no such weather, and we are therefore unable to do more than indicate this as a possibility.

Analysis of the sensitivity of a perfect Carnot heat pump to external temperature suggests that with a heat output temperature of 60°C, a 1°C change in external temperature would change the SPF by about 1.3%. A system with a 30°C heat output temperature might have a 1°C sensitivity of 3%, but only for space heating.



**Figure 3-1. Box plots for ASHPs in Sample C of unadjusted SPFs and adjusted SPFs to UKSET conditions (mean indicated by the red line, median by the dashed black line, interquartile range by the blue box)**



**Figure 3-2. Box plots for GSHPs in Sample C of unadjusted SPFs and adjusted SPFs to UKSET conditions (mean indicated by the red line, median by the dashed black line, interquartile range by the blue box)**

Although adjustment to UKSET conditions has resulted in little or no substantive difference in performance across Sample C as a whole, these adjusted SPF<sub>H4</sub> are used in much of subsequent analysis below. However, when examining heat pump characteristics in detail, for example, when considering variations in load factor, we have used the unadjusted data from Sample B or C. This allows us to use more data, over a longer period, and avoids the interpretational complexities involved in basing detailed analysis on modelled data. We have noted which dataset is under consideration throughout.

**Table 3-3. Adjusted Mean SPF<sub>H4</sub> for Sample C compared with the Preliminary Findings (using data from December 2013) and from EST HP Trial Phase I (SPF<sub>H5</sub>) and Phase II (SPF<sub>H4</sub>).**

SPF	HP type	Sample C adjusted		Prelim. Findings (Dec. 2013) <sup>a</sup>		EST HP Field Trial Phase I & II	
		N	Mean (± Std. Error)	N	Mean (± Std. Error)	N	Mean (± Std. Error)
SPF <sub>H4</sub>	ASHP	223	2.30 (±0.03)	289	2.43 (±0.04)	15	2.45 <sup>b</sup> (±0.11)
	GSHP	76	2.75 (±0.09)	124	2.92 (±0.08)	22	2.82 <sup>b</sup> (±0.10)
SPF <sub>H5</sub>	ASHP	223	2.18 (±0.03)	289	2.34 (±0.04)	22	1.84 <sup>c</sup> (±0.09)
	GSHP	76	2.48 (±0.08)	124	2.74 (±0.08)	49	2.39 <sup>c</sup> (±0.08)

<sup>a</sup> As reported in the report on Preliminary data from the RHPP heat pump metering programme (Wickins, 2014.)

<sup>b</sup> SPF<sub>H4</sub> reported in findings from Phase II of the EST Heat Pump Field Trials (Dunbabin et al., 2013).

<sup>c</sup> SPF<sub>H5</sub> reported in findings from Phase I of the EST Heat Pump Field Trials (Dunbabin & Wickins, 2012.) and defined in Gleeson & Lowe, 2013.

In comparison with previous findings from the UK (using unadjusted data), the results for SPF<sub>H4</sub> under UKSET conditions presented in Table 2 are lower than those from the preliminary report on the RHPP metering data, which is likely due to these early estimates for annual performance being based on just one month of winter data, specifically from December 2013 (Wickins, 2014). The mean SPF<sub>H4</sub> figures are also slightly lower than reported for the EST HP Phase II field trial (Dunbabin et al. 2013), however this is likely to be due to differences in study design, since that analysis included sites that been subjected to interventions to address performance issues that were revealed by initial phase of monitoring for the study<sup>6</sup>. While Phase I of the EST HP field trials does provides a more comparable snapshot of HP system performance, it uses SPF<sub>H5</sub> to measure performance. Adopting the same basic assumption of 30% heat losses from the hot water cylinder as was done in the preliminary analysis of RHPP data (Wickins, 2014),

<sup>6</sup> The EST Phase II study included 44 sites. Interventions were carried out to improve performance on 32 of these sites. Of these interventions, 12 were described as major, 9 as medium and 11 as minor.

the mean  $SPF_{H15}$  results for ASHPs here are considerably higher than for Phase I of the EST trial (which had markedly improved performance by Phase II), whereas results for GSHPs are in agreement within the margin of error.

**Table 3-4. Percentage of HP systems that met the  $SPF_{H2} \geq 2.5$  criterion under the EU Renewable Energy Directive (with upper and lower limits based on the standard error in the population mean estimates of  $SPF_{H2}$ )**

Sample	HP type	Percentage $SPF_{H2} \geq 2.5$	95% Confidence Interval
<b>Sample B</b>	ASHP	58%	52 – 64%
	GSHP	78%	68 – 88%
<b>Sample C</b>	ASHP	63%	55 – 71%
	GSHP	76%	66 – 86%
<b>Sample C Adjusted</b>	ASHP	55%	49 – 61%
	GSHP	79%	69 – 89%

In terms of the estimates for the amount of renewable energy generated by heat pumps needed for the EU Renewable Energy Directive, the EU Commission Decision of 1<sup>st</sup> March 2013 defines the relevant measure of efficiency to be  $SPF_{H2}$ , i.e. the efficiency of the heat pump without the inclusion of electricity used for backup or distribution circulation pumps. The Directive considers heat pumps to be classed as a renewable energy source provided that  $SPF_{H2} \geq 2.5$ .<sup>7</sup>

From Table 3-4 (and based on the distributions obtained for  $SPF_{H2}$  as shown in Figure 5 or Figure A-10), findings for Sample C under UKSET conditions indicate that 55% of ASHPs and 79% of the GSHPs can be thus classified as sources of renewable energy. The figure for ASHPs appears lower (but still within the 95% confidence interval) than for unadjusted data from Sample C (63%), which were for a relatively warm year. As would be expected, the results for Sample B are in closer agreement with the adjusted figures, given that this sample uses data for the SPF calculations from different annual periods according to the data quality available at each site and hence is less affected by any particular year. As the threshold value for classification as a renewable energy source is close to the mean and the median for ASHPs, only small changes after adjustment to UKSET conditions can result in relatively large shifts in the percentage

<sup>7</sup> But note that the logic of the Directive is that this threshold SPF would fall as electricity decarbonises across the EU.

attaining the threshold value of  $SPF_{H2} \geq 2.5$ . For these figures to be generalised to the current stock of heat pumps, it must be assumed that sample on which it is based is representative of the stock of HP systems in the UK. In all cases, however, the results here indicate that a large proportion (between a third and just under a half) of ASHPs and just over 20% of GSHPs were not operating with sufficient efficiency to be classified as renewable sources of energy under the Directive.

To give an indication of the renewable heat generated under UKSET conditions (Table 3-5), on average ASHPs with  $SPF \geq 2.5$  produced 10,000 kWh each, whereas if this output were shared across all the whole sample (i.e. including sites that did not attain the required level of efficiency) then the mean renewable heat output almost halved to 5,000 kWh. The corresponding figures for GSHPs were markedly higher, at 14,600 kWh and 11,500 kWh respectively, reflecting the higher proportion of sites classified as contributing to renewable energy generation.

**Table 3-5. Estimated renewable heat outputs (from Sample C, adjusted to UKSET conditions)**

HP type	N	%	Sites with $SPF_{H2} \geq 2.5$	All sites
			Mean renewable heat output, kWh ( $\pm$ Std. Err.)	Mean renewable heat output, kWh ( $\pm$ Std. Err.)
ASHP	223	55%	10,000 ( $\pm$ 450)	5,500 ( $\pm$ 300)
GSHP	76	79%	14,600 ( $\pm$ 1,500)	11,500 ( $\pm$ 1,350)

### 3.2 Savings relative to alternative technologies

This section compares HPs to 5 counterfactual systems – Gas boiler, LPG boiler, oil boiler, storage heater (economy 7) and coal. While not directly relevant to the subsequent comparative analysis, which is based on the measured performance of all HP systems in the Samples B and C, Table 3-6 gives an indication of the extent that HP systems installed via the RHPP scheme have replaced other fuels in practice. The RHPP scheme was aimed at properties off the gas grid. In the private sector, oil was the fuel most commonly replaced (around 57% of cases), followed by electricity (around 29%). In the social housing sector, electricity was the fuel most commonly replaced (around 55%), with a high proportion of “not known” and a relatively high proportion of coal fires (15% for ASHPs, 6% for GSHPs).

**Table 3-6. Percentage of different fuels actually replaced in the RHPP sample**

	Coal, smokeless fuel	Wood	Electricity	Oil	LPG	Not known	Installations N (%)
<b>Private Sector</b>							
<b>ASHP</b>	5%	2%	29%	57%	8%	-	5902 (73%)
<b>GSHP</b>	5%	2%	26%	58%	8%	-	2230 (27%)
<b>Registered Social Landlords (RSLs)</b>							
<b>ASHP</b>	15%	2%	55%	6%	1%	22%	5411 (88%)
<b>GSHP</b>	6%	2%	55%	1%	0%	36%	755 (12%)

Table 3-7 shows the annual mean CO<sub>2</sub> savings (using the carbon intensities and other specifications given in Table 5 and not over the installed life) and the estimated proportion of sites that would result in CO<sub>2</sub> reductions if displacing each fuel in turn. These figures are based on the distributions of heat output and electricity input obtained for Sample C under UKSET conditions. The “CO<sub>2</sub> +10%” column represents the case where the mean internal temperature increases by about 1°C when a heat pump is installed. This recognises the potential for higher mean internal temperatures in dwellings with heat pumps resulting from a shift towards continuous heating. Such a shift would necessary to achieve the same internal temperatures during heating-on periods that would have been achieved by a boiler fired with oil, LPG or natural gas, due to the lower heat output rating of a heat pump compared with such systems. The overall effect would be to increase demand for space heating by around 10%. Note that internal temperatures were not monitored in this study, so it is not known whether this effect actually occurred or not. Also note that the RHPP scheme was focussed on properties off the gas grid; however, an assessment of the carbon savings relative to natural gas has also been included as a comparison benchmark for best performance among fossil fuel energy sources (and assuming that a condensing gas boiler provides the hot water and space heating). In the longer run, conversion of a significant proportion of gas heated dwellings to heat pumps would be one strategy to decarbonise the domestic heating sector.

The findings indicate that even under the increased heating demand scenario over 94% of ASHPs and 95% of GSHPs have reduced CO<sub>2</sub> emissions compared with the use of electricity, coal, oil, and LPG. Annual mean CO<sub>2</sub> savings per site are substantial even for ASHPs, varying from 4.1 tonnes for coal to 1.0 tonne CO<sub>2</sub> for LPF (for fuels other than gas). The CO<sub>2</sub> +10% scenario covering increased space heating

with HP systems lowers these savings slightly. Histograms for each fuel are given in the Appendix (Figures A11- A18).

**Table 3-7. Mean annual CO<sub>2</sub> savings and percentage of HP systems under UKSET conditions likely to yield CO<sub>2</sub> reductions relative to other fuels (including 10% increased space heating demand scenario)**

Displaced fuel <sup>a</sup>	ASHP mean CO <sub>2</sub> savings (Tonnes)		GSHP mean CO <sub>2</sub> savings (Tonnes)	
	CO <sub>2</sub>	CO <sub>2</sub> +10% <sup>b</sup>	CO <sub>2</sub>	CO <sub>2</sub> +10% <sup>b</sup>
<b>Electricity (Std.)</b>	2.0 (99%)	1.8 (99%)	3.3 (99%)	3.0 (97%)
<b>Electricity (E7)</b>	2.0 (99%)	1.8 (99%)	3.3 (99%)	3.0 (97%)
<b>Coal</b>	4.1 (100%)	3.7 (100%)	6.3 (99%)	5.8 (99%)
<b>Oil</b>	1.3 (96%)	1.1 (96%)	2.4 (96%)	2.1 (96%)
<b>LPG</b>	1.0 (95%)	0.8 (94%)	1.8 (96%)	1.6 (95%)
<b>Gas<sup>c</sup></b>	0.6 (93%)	0.5 (87%)	1.3 (95%)	1.1 (91%)

<sup>a</sup> Carbon intensity used for the fuels displaced are as given in Table 2-2, with HP systems using the carbon intensity of electricity (with this the same for both the standard and E7 tariff)

<sup>b</sup> The calculation is repeated allowing for a 10% increase in space heating demand with heat pumps. This recognises the potential for higher mean internal temperatures in dwellings with heat pumps resulting from a shift towards continuous heating.

<sup>c</sup> Gas is included only as a benchmark indicator of the current best performing conventional heating system (gas-fired condensing boilers) in terms of cost and CO<sub>2</sub> emissions.

Estimated fuel cost savings are shown in Table 3-8 in a single year (using the costs and other specifications given in Table 2-2 and not over the installed life), where HP systems use electricity at the standard tariff. It is estimated that at least 89% of GSHPs and 82% of ASHPs have reduced household bills compared against electricity, LPG and coal, though the figures drop markedly for oil (eg 64% for ASHPs). Note also that oil prices have fallen since the date selected for this analysis (October 2014). The findings indicate annual mean cost savings per site vary widely, for instance for ASHPs savings are from £845 for standard electricity to £70 for oil (considering fuels other than Gas). The CO<sub>2</sub> +10% scenario covering increased space heating with HP systems lowers these savings considerably in some cases, for example down to £39 per year for oil replaced by ASHPs.



**Table 3-8. Mean annual fuel cost savings and percentage of HP systems expected to yield energy cost savings relative to other fuels (including a scenario with 10% increased heat demand)**

Displaced fuel <sup>a</sup>	ASHP mean cost savings (£)		GSHP mean cost savings (£)	
	Cost	Cost _10%	Cost	Cost _10%
<b>Electricity (Std)</b>	845 (99%)	731 (99%)	1388 (99%)	1255 (97%)
<b>Electricity (E7)</b>	146 (82%)	98 (73%)	372 (89%)	307 (89%)
<b>Coal</b>	232 (92%)	171 (84%)	500 (93%)	426 (91%)
<b>Oil</b>	70 (64%)	39 (46%)	242 (83%)	190 (79%)
<b>LPG</b>	323 (95%)	252 (93%)	634 (95%)	549 (93%)
<b>Gas</b>	12 (19%)	4 (9%)	98 (53%)	68 (34%)

<sup>a</sup> Fuel costs for each of the displaced fuels are set as given in Table 2-2, with HP systems using the standard electricity tariff.

<sup>b</sup> The calculation is repeated, but allowing for a 10% increase in heating demand with heat pumps. This recognises the potential for higher mean internal temperatures in dwellings with heat pumps resulting from a shift towards continuous heating.

<sup>c</sup> Gas is included only as an indicator of the best performing conventional heating system in terms of cost and CO<sub>2</sub> emissions.

### 3.3 Variation in monthly performance of HP systems

Before investigating other characteristics of heat pump operation in more detail, it is worthwhile to move beyond yearly statistics and examine the monthly variation in the efficiency. To that end, Sample B has been used as this has both the largest sample size and the longest duration of measurements (with useful data from December 2012 to March 2015). Corresponding to the methods used for annual  $SPF_{H4}$ , a monthly Coefficient of Performance (COP) for the H4 boundary was calculated from the integrated heat delivered divided by the integrated electricity consumption in each calendar month to produce  $COP_{H4}$ . The reason for the adoption of COP terminology to describe efficiency on a monthly basis is to distinguish this measure from SPF, which has been set by definition as a measurement of annual performance measurement.

The changes in the distributions of monthly  $COP_{H4}$  for all sites in Sample B are shown in Figure 3-3, where distributions for months prior to April 2012 have relatively few sites compared with subsequent months. A periodic annual dip in  $COP_{H4}$  from June to August is clearly evident for the ASHP systems, which suggests their efficiency is affected as space heating declines and when only needing to meet the

needs of hot water demand. This pattern in variations in  $COP_{H4}$  during summer was not as evident for the GSHP systems, though the interquartile range increased during those months suggesting that some sites were affected. Further investigation of these variations is warranted in future work, for instance related to their impact on SPFs (annual performance) as well as the role of external temperature and geographical location on their prevalence.

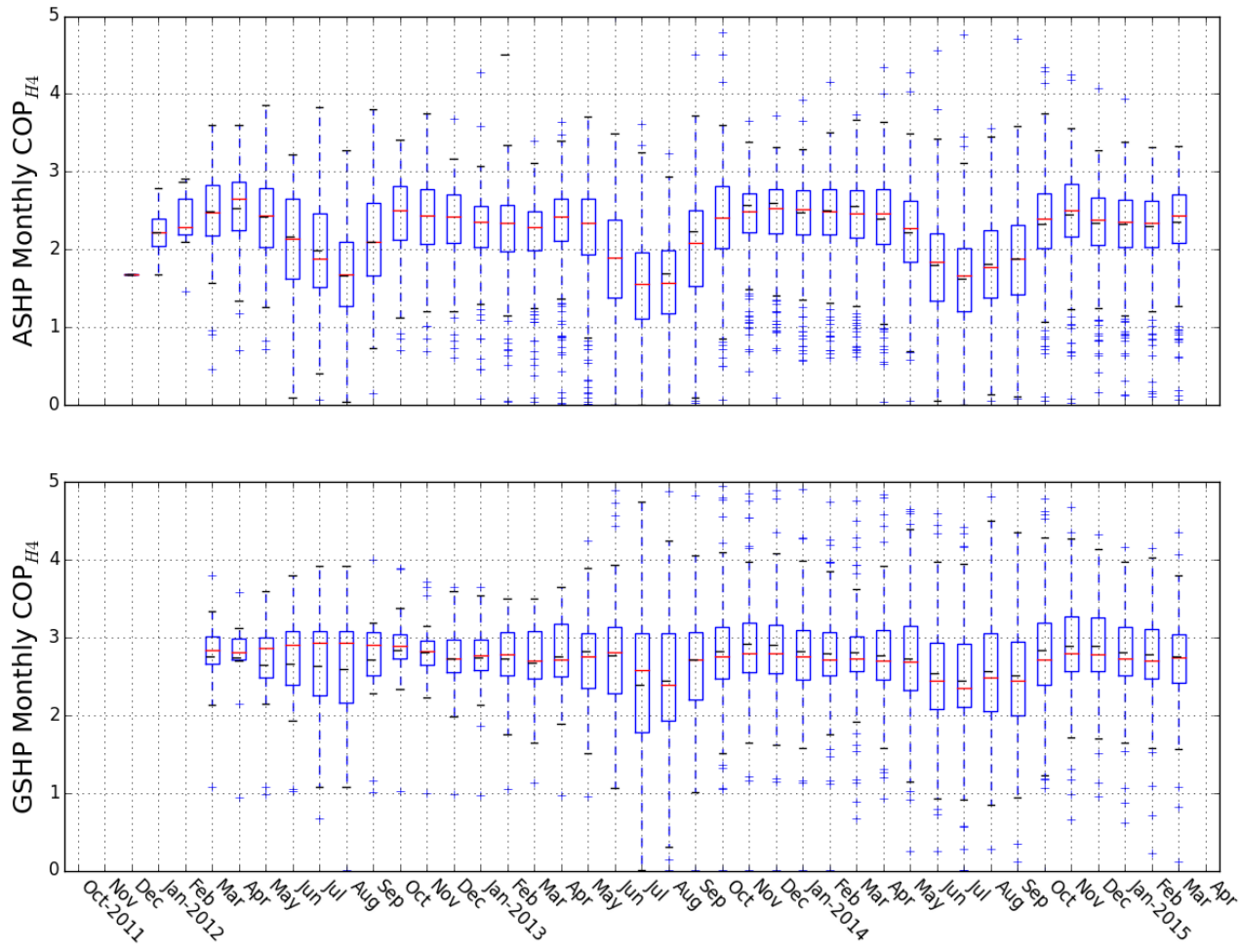


Figure 3-3. Box plot of monthly COP<sub>H4</sub> for ASHPs from Sample B

### 3.4 Modes of operation

As the next step of looking at the characteristics of HP system operation, and moving beyond efficiency figures for SPF<sub>s</sub> and monthly COP<sub>s</sub>, *data from Sample B* have been used to examine the different modes that characterise heat pump operation. Operating mode has not been directly monitored as part of the RHPP monitoring programme, however it is possible to infer this by looking at the measured flow temperatures, heat and mass flow rates. In this analysis, a heat pump is classified to be in one of four modes at each time period for which there is data:

1. Space heating mode, where heat is being actively delivered to the space heating circuit (though not necessarily at full capacity).
2. Water heating mode, where heat is being actively delivered to the water heating circuit
3. Circulating only, where fluid is being circulated but no heat is delivered. In this mode the fluid is almost certainly being circulated through the space heating circuit, this might therefore be considered a special case of space heating mode. The system may operate in this mode for a variety of reasons, including pump overrun (where the pump continues to operate for a short period after the heat pump has stopped heating), cycling, defrost mode for ASHPs, misconfiguration, etc.
4. Off, where no fluid is being circulated. There is likely to be a small power consumption during this time due to control systems and other parasitic loads.

A hot water immersion heater, if present, may in principle operate independently of the main heat pump mode. The use of domestic hot water immersion will be studied further in a future report on the reasons for good and poor performance.

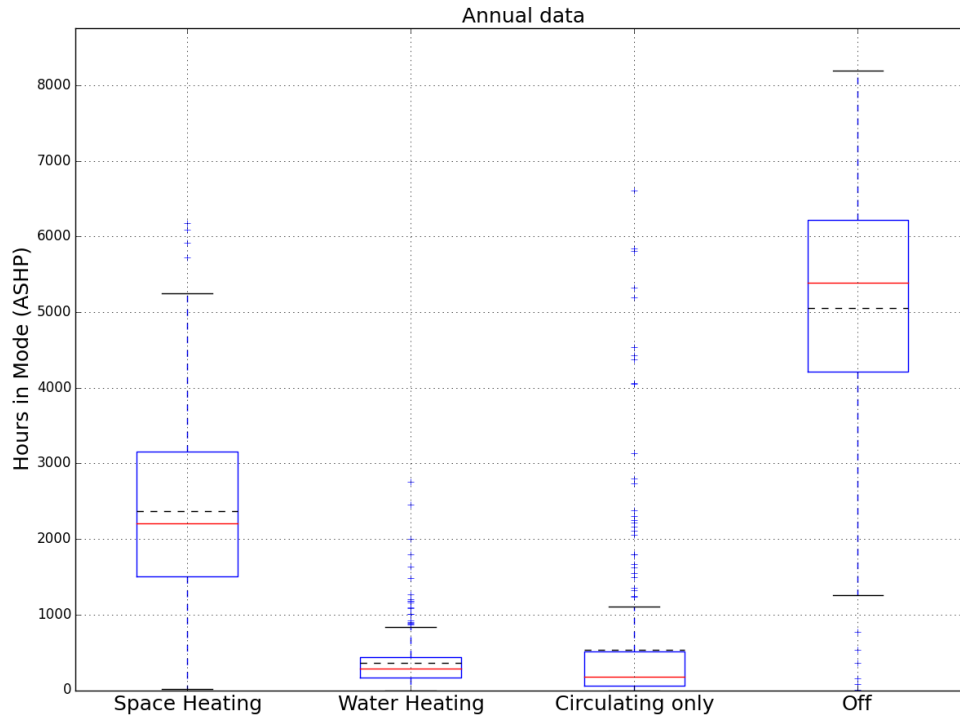
#### Annual Operating Hours

Using data from Sample B, Figures 3-3 and 3-4 show the annual distribution of hours spent in each operating mode for ASHP and GSHP systems respectively<sup>8</sup>, Table 3-9 summarises key statistics of the distributions. There are 8760 hours in the analysis year. The results show that a reasonably large proportion of GSHP installations spend a substantial number of hours with the circulation pumps operating but no heat delivered (25% of GSHPs are in circulating mode only for more than 3,200 hours per year, 25% of GSHPs are in the off mode for less than 1,400 hours per year). This may be due to the use of underfloor heating, although further work needs to be carried out to confirm this. The median time spent in space heating mode is similar for ASHPs and GSHPs (2,200 and 1,680 hours per year

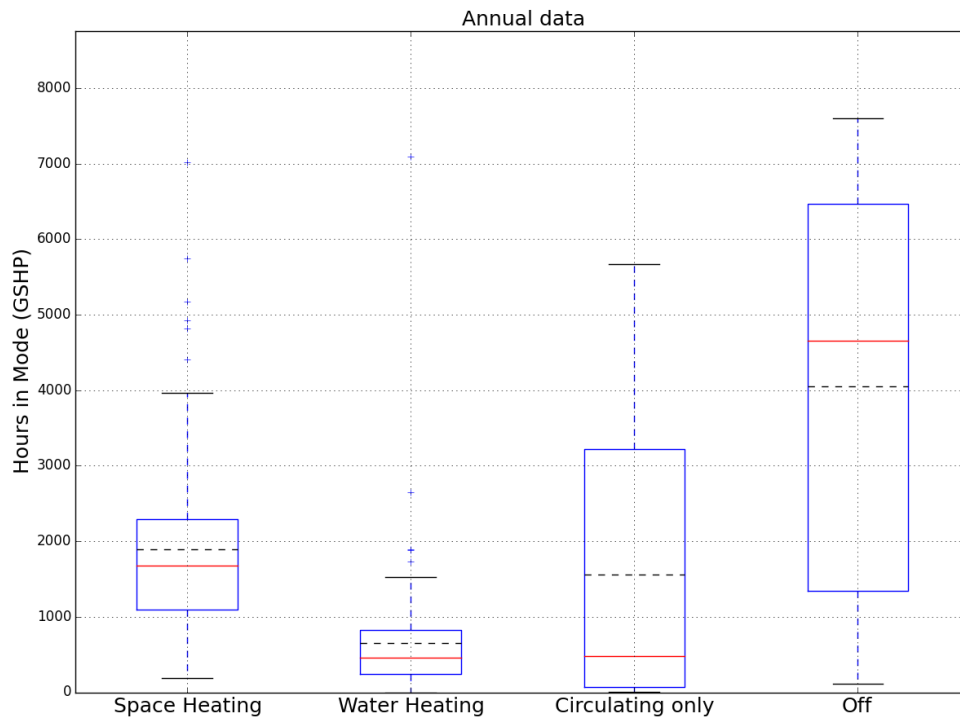
---

<sup>8</sup> Note that the calculation of annual operating hours spent in each mode of operation does not take account of variable output of modulating heat pumps. This is simply the time spent in each of the four operating modes.

respectively), however the median time that ASHPs spent in water heating mode was substantially lower than GSHPs (281 and 454 hours per year respectively).



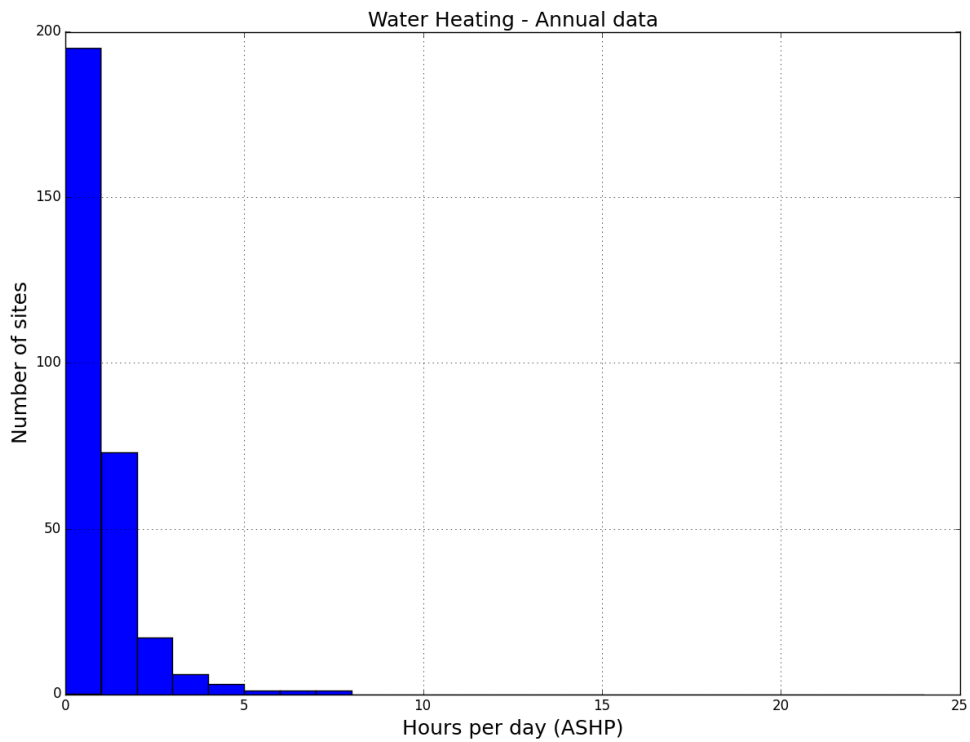
**Figure 3-4. Air Source Heat Pump (ASHP) Annual Hours of Operation**



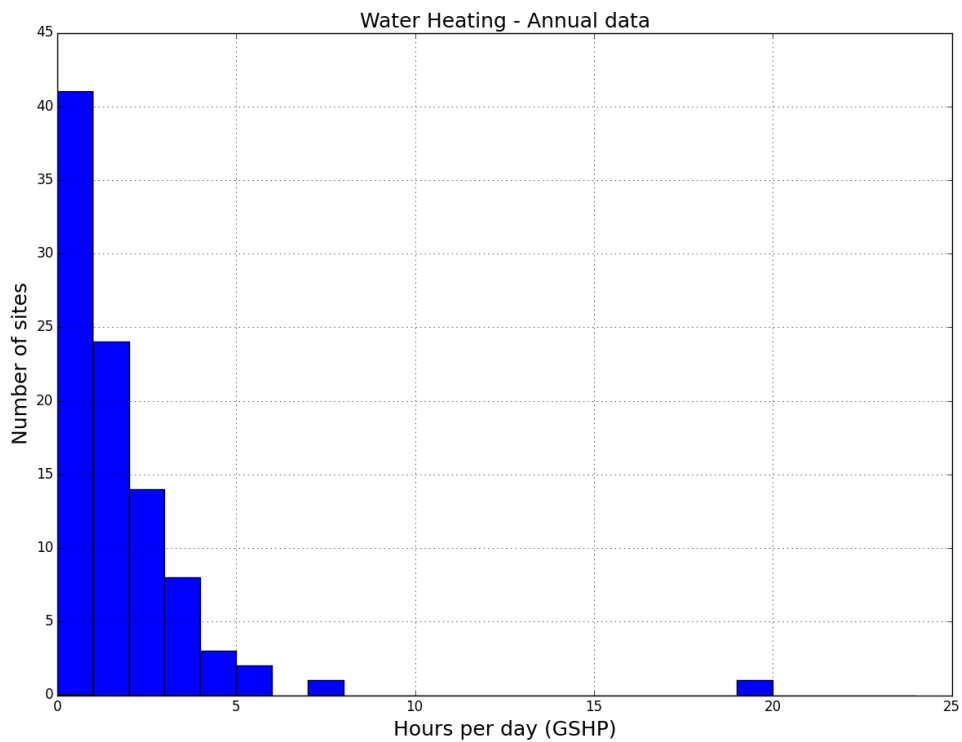
**Figure 3-5. Ground Source Heat Pump (GSHP) Annual Hours of Operation**

**Table 3-9. Summary statistics of number of hours in each operating mode (annual, all figures in hours)**

Operating Mode	HP Type	N	Mean (SD)	% of time	Median (IQR)
<b>Space heating</b>	ASHP	297	2372 (1191)	28.5	2204 (1501-3152)
	GSHP	94	1895 (1211)	23.2	1680 (1095-2294)
<b>Water heating</b>	ASHP	297	360 (347)	4.3	281 (162-442)
	GSHP	94	654 (834)	8	454 (247-824)
<b>Circulating only</b>	ASHP	297	530 (996)	6.4	175 (59-516)
	GSHP	94	1559 (1875)	19.1	484 (69-3222)
<b>Off</b>	ASHP	297	5057 (1636)	60.8	5385 (4214-6219)
	GSHP	94	4051 (2461)	49.7	4659 (1343-6467)



**Figure 3-6. Distribution of average hours per day spent in water heating mode (ASHPs)**



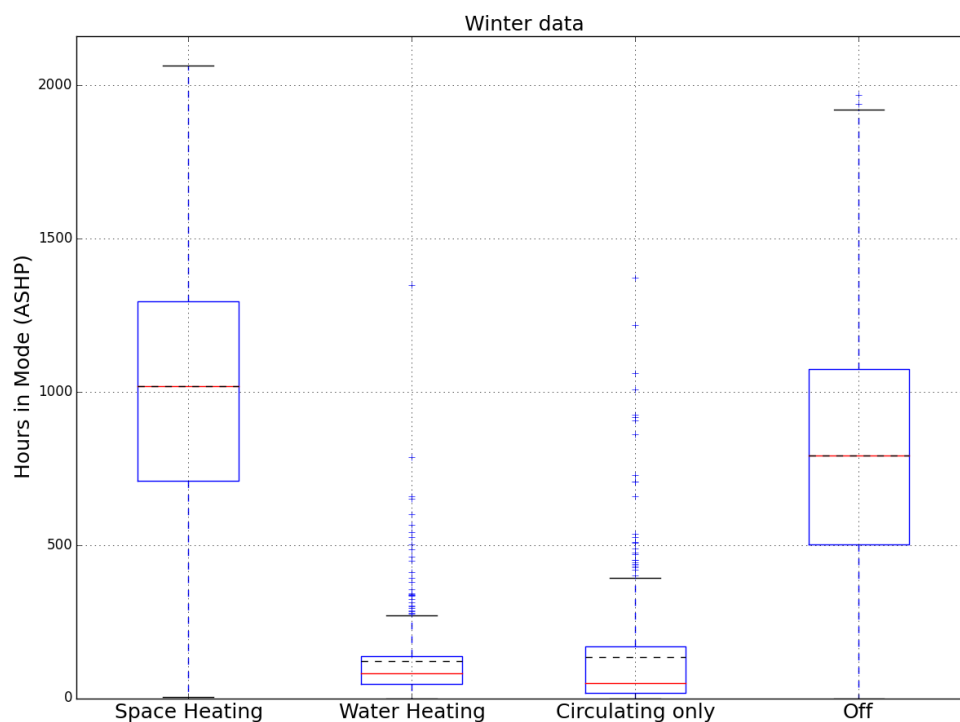
**Figure 3-7. Distribution of average hours per day spent in water heating mode (GSHPs)**

Figures 3-6 and 3-7 show the average annual hours per day spent in water heating mode for ASHPs and GSHPs. There is a clear outlier on the GSHP plot, which illustrates that further analytical or diagnostic

work is needed in this case as this is likely due to an issue with the algorithm for detecting this mode of operation.

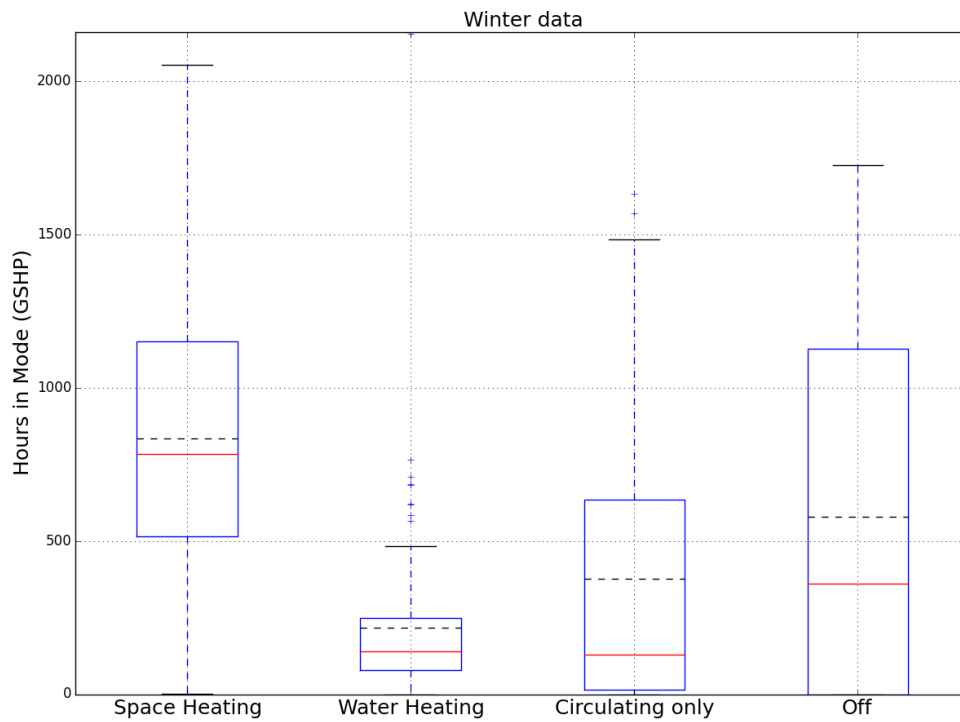
## Winter Operating Hours

Using data from *Sample B*, Figures 3-8 and 3-9 show the distribution of hours spent in each operating mode for ASHPs and GSHPs during the winter months of December, January, and February (2,160 hours in total). Table 3-10 summarises key statistics of the distributions. Again, the results show that many GSHPs in the sample spend significant hours circulating fluid through the heating system but not delivering any useful heat. Indeed 25% of the GSHPs spend 30% or more of their time in winter months just circulating fluid.



**Figure 3-8. Air Source Heat Pump (ASHP) Winter Hours of Operation**





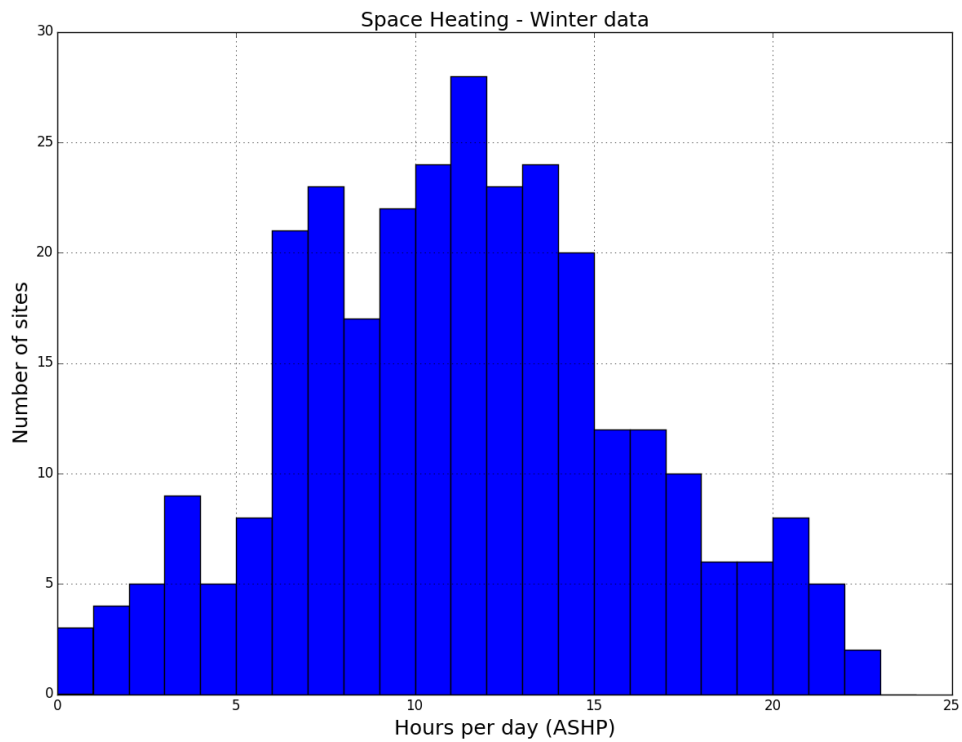
**Figure 3-9. Ground Source Heat Pump (GSHP) Winter Hours of Operation**

**Table 3-10. Summary statistics of number of hours in each operating mode (winter)**

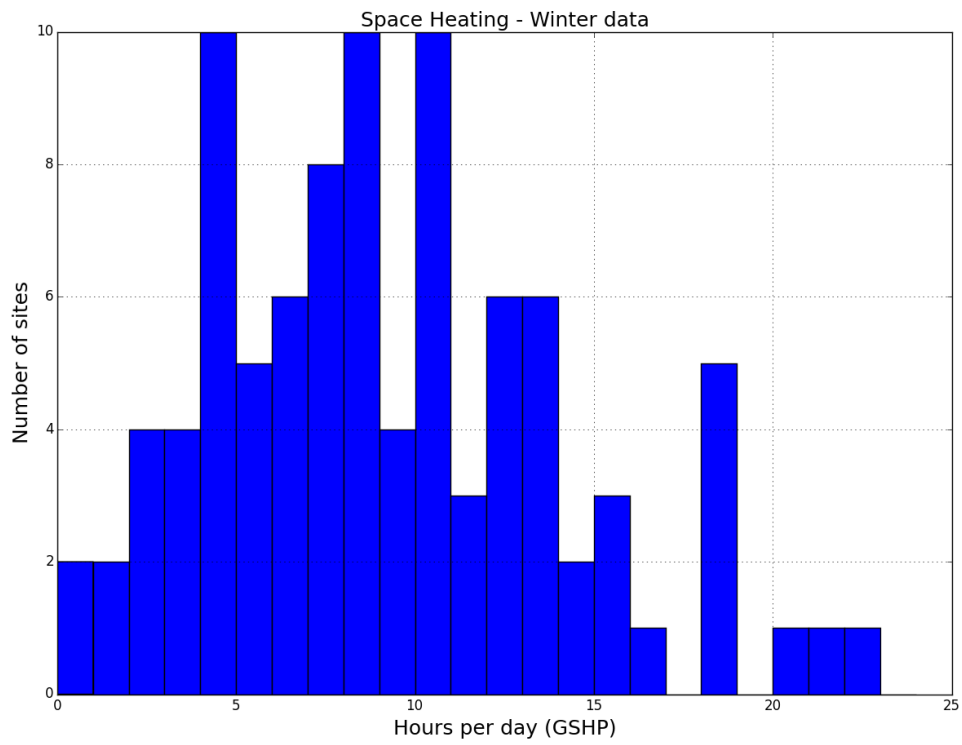
Operating Mode	HP Type	N	Mean hours (SD)	% of time	Median hours (IQR)
<b>Space heating</b>	ASHP	297	1018 (425)	49.3	1017 (708-1294)
	GSHP	94	835 (448)	41.6	784 (516-1149)
<b>Water heating</b>	ASHP	297	122 (141)	5.9	81 (47-138)
	GSHP	94	217 (272)	10.8	140 (77-248)
<b>Circulating only</b>	ASHP	297	134 (206)	6.5	50 (16-168)
	GSHP	94	376 (465)	18.8	128 (16-634)
<b>Off</b>	ASHP	297	791 (432)	38.3	791 (502-1073)
	GSHP	94	577 (589)	28.8	359 (0-1127)

Figures 3-10 and 3-11 show the average number of hours per day spent in space heating mode for ASHPs and GSHPs respectively. For comparison, Figures 3-12 and Figure 3-13 show the average hours per day

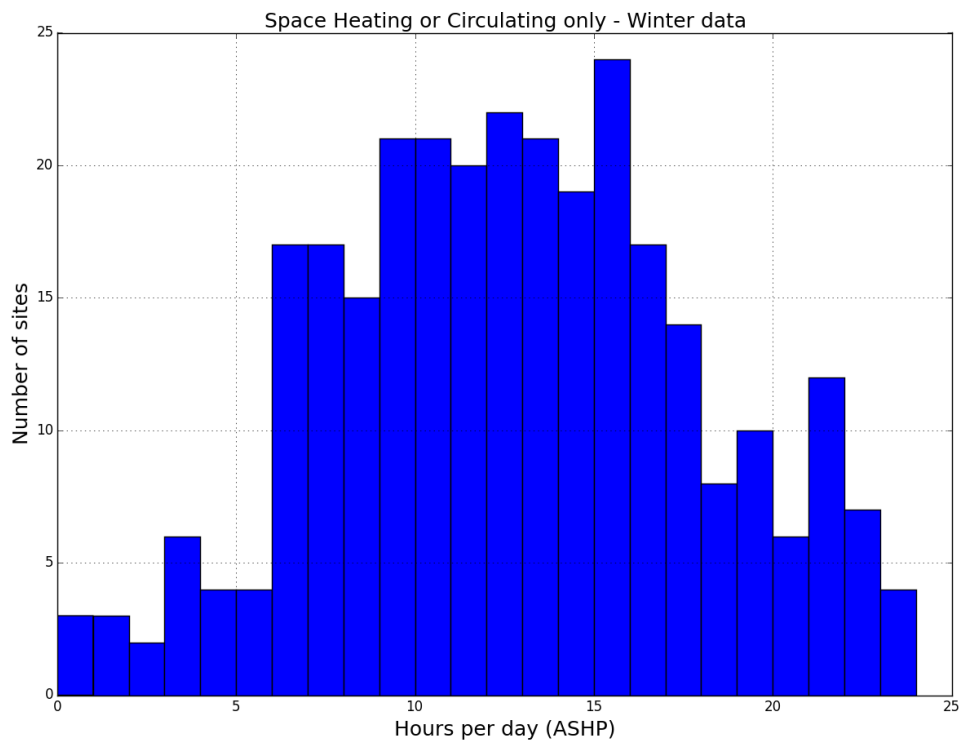
spent in either space heating mode or circulating only mode (i.e. the circulation pumps are operating but no useful heat is delivered). This might be more representative of the programmed operating hours of the heat pump. These second plots make clear that the GSHPs can be categorised into those that operate 24 hours per day and those that do not (given the bimodal distribution in Figure 3-13). Table 3-11 provides a summary table of the percentage of sites with different lengths of operating time for space heating (categorised into four levels), with shorter time lengths (0-12 hours) more prevalent for GSHPs than ASHPs.



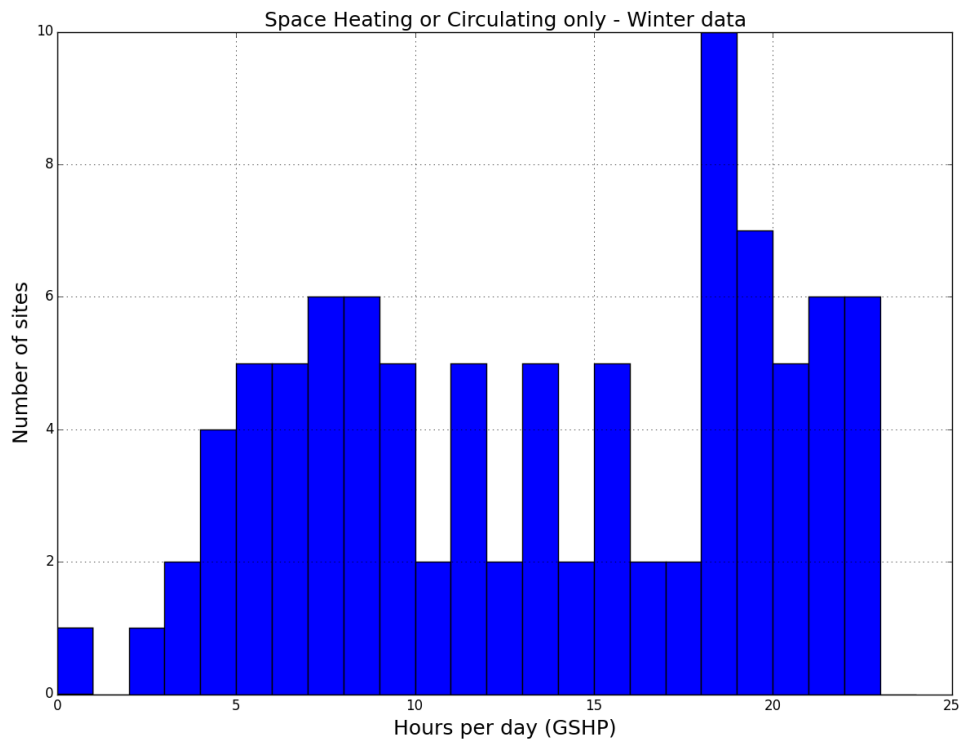
**Figure 3-10. Distribution of hours per day spent in space heating mode for ASHPs during winter months**



**Figure 3-11. Distribution of hours per day spent in space heating mode for GSHPs during winter months**



**Figure 3-12. Distribution of hours per day spent in space heating or circulating only mode for ASHPs during winter months**



**Figure 3-13. Distribution of hours per day spent in space heating or circulating only mode for GSHPs during winter months**

**Table 3-11. Hours per day spent in space heating mode for ASHPs and GSHPs during winter months**

Average Operating Hour Range Per Day (Winter)	ASHPs N (%)	GSHPs N (%)
0-6	34 (11)	27 (29)
>6-12	135 (45)	41 (44)
>12-18	101 (34)	18 (19)
>18-24	27 (9)	8 (9)

### 3.5 Load factors

In this section, the statistics for load factors are calculated with a progressive reduction in the time period evaluated, from annual, to winter months, and then monthly. The annual load factor at each site in

Sample B refers to the heat output (at the H2 and H4 system boundary) as a fraction of the nameplate capacity of the HP to deliver heat, and is expressed as a percentage. Statistics for annual load factors are useful as this is often a key modelling assumption. The average winter load factors (Table 2-13 and 3-13) for both hot water and space heating at the H2 boundaries appear slightly lower for ASHPs (13%) than for GSHPs (17%) (with similar slightly higher figures for the H4 boundary). Though as is evident from the interquartile range, there is considerable overlap.

**Table 3-12. Annual load factors (%) at the H2 boundary**

Heating Type	HP Type	N	Mean % (SD)	Median % (IQR)
Space heating	ASHP	297	10.8 (11.2)	7.4 (1.7-16.8)
	GSHP	94	11.6 (12.3)	7.5 (1.4-18.3)
Water heating	ASHP	297	2.3 (2.6)	1.7 (0.7-2.9)
	GSHP	94	5.2 (5.9)	3.6 (1.6-6.8)
All	ASHP	297	13.1 (11.7)	10.1 (3.6-19.7)
	GSHP	94	16.8 (14.1)	13.1 (5-25.3)

**Table 3-13. Annual load factors (%) at the H4 boundary**

Heating Type	HP Type	N	Mean % (SD)	Median % (IQR)
Space heating	ASHP	297	11.6 (11.6)	8.1 (2.1-17.8)
	GSHP	94	12 (12.4)	7.9 (1.8-18.7)
Water heating	ASHP	297	2.4 (2.7)	1.8 (0.8-3)
	GSHP	94	5.3 (5.9)	3.6 (1.6-6.9)
All	ASHP	297	14 (12.2)	10.9 (4.1-20.6)
	GSHP	94	17.3 (14.3)	13.3 (5.3-25.8)

The winter load factor can provide some further insights on system usage relative to its capacity, and hence on system sizing. The winter load factor at each site in Sample B (from December to February) refers to the heat output (at the H2 and H4 system boundary) as a fraction of the nameplate capacity of the HP to deliver heat, and is expressed as a percentage. Summary statistics for load factors across ASHP

and GSHP sites (Tables 3-14 and 3-15) provide an indication of systems use relative to their potential to meet the heating demands placed on them. The average winter load factors for both hot water and space heating at the H2 boundaries were slightly lower for ASHPs (23%) than for GSHPs (30%), with similar slightly higher figures for the H4 boundary. While oversizing is not immediately apparent in either case, analysis in more detail is required (at even higher resolution than monthly data, and possibly using the periods of the coldest consecutive days), before more definitive conclusions on sizing can be drawn.

**Table 3-14. Winter load factors (%) at the H2 boundary**

Heating Type	HP Type	N	Mean % (SD)	Median % (IQR)
Space heating	ASHP	297	20.7 (12)	19.2 (12.9-27.6)
	GSHP	94	22.9 (13.8)	22.5 (11.7-31.1)
Water heating	ASHP	297	2.8 (3.2)	2 (0.8-3.6)
	GSHP	94	7.7 (8.7)	4.6 (2.5-9.8)
All	ASHP	297	23.5 (12.4)	22 (15.4-30.9)
	GSHP	94	30.6 (15)	31 (18.4-40.3)

**Table 3-15. Winter load factors (%) at the H4 boundary**

Heating Type	HP Type	N	Mean % (SD)	Median % (IQR)
Space heating	ASHP	297	21.7 (12.3)	20.1 (13.7-28.8)
	GSHP	94	23.5 (13.9)	23 (12.2-31.6)
Water heating	ASHP	297	2.9 (3.3)	2 (0.8-3.6)
	GSHP	94	7.8 (8.9)	4.6 (2.6-9.9)
All	ASHP	297	24.6 (12.8)	22.9 (16.3-32)
	GSHP	94	31.3 (15.2)	31.8 (19.3-41.3)

As load factors are greatly affected by seasonal conditions and the need for space heating, box plots of monthly load factors at each site (Figures 3-14 and 3-15) provide more information on the variation

through the year. As expected they have a similar pattern, with a dip during summer months, as the earlier box plots of monthly COP. Also note as previously with the Sample B data, the number of sites included in the monthly calculation rises as sites with monitoring data increases through the first part of the study period. Even during the coldest months, it appears that monthly load factors for the vast majority of ASHP and GSHP sites are well below 50%, but with some outliers among the AHPS systems with load factors above 80% across the winter months. Further more detailed investigation using load factors to investigate the extent of over and under sizing will be included in future analysis.

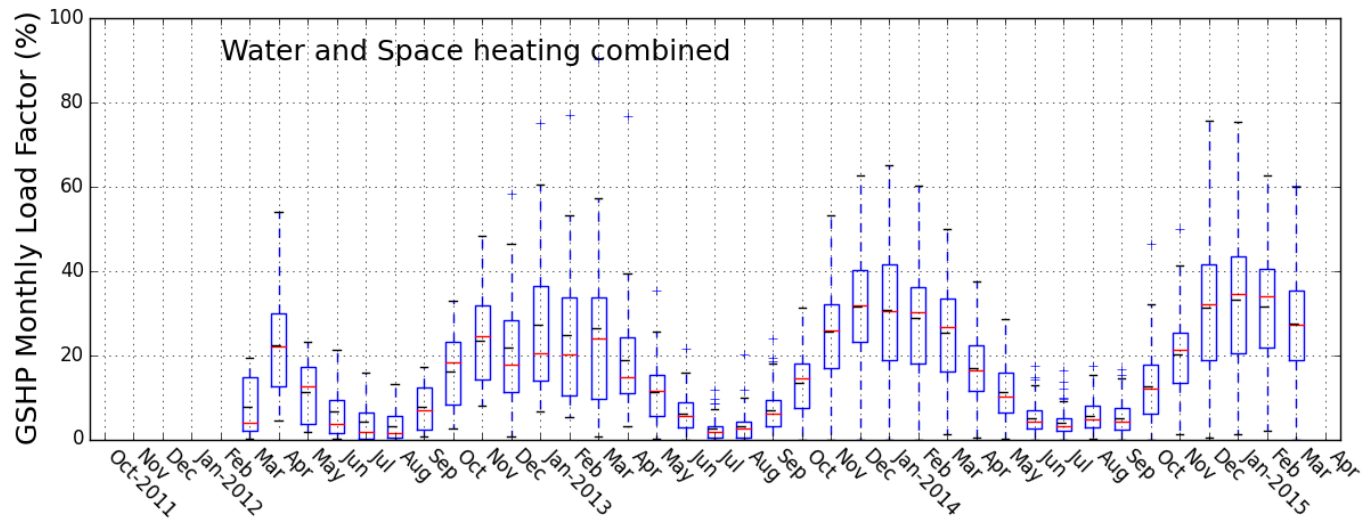
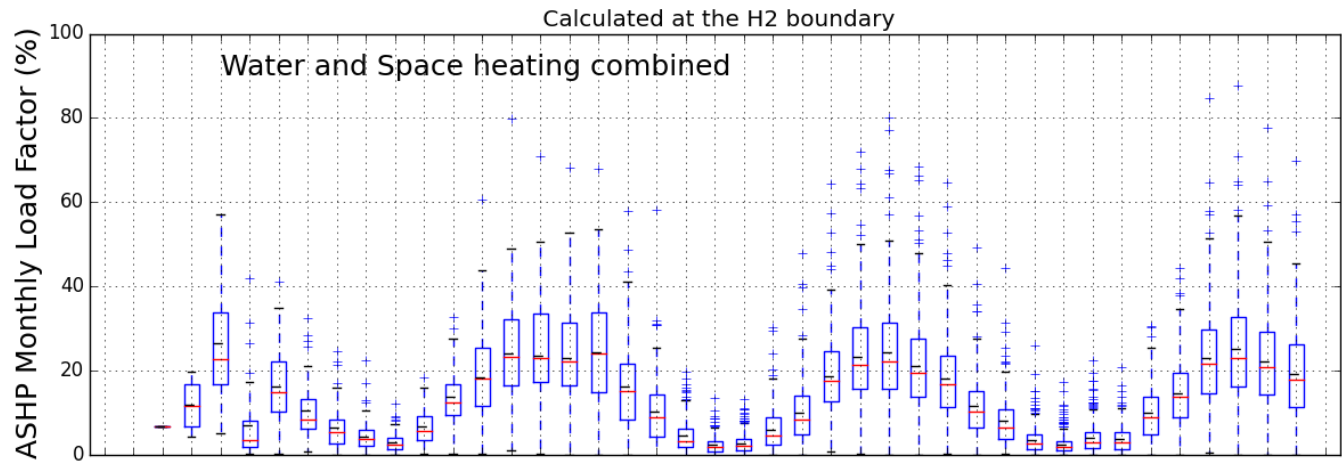


Figure 3-14. Box plots of monthly load factors at H2 system boundary for ASHPs and GSHPs



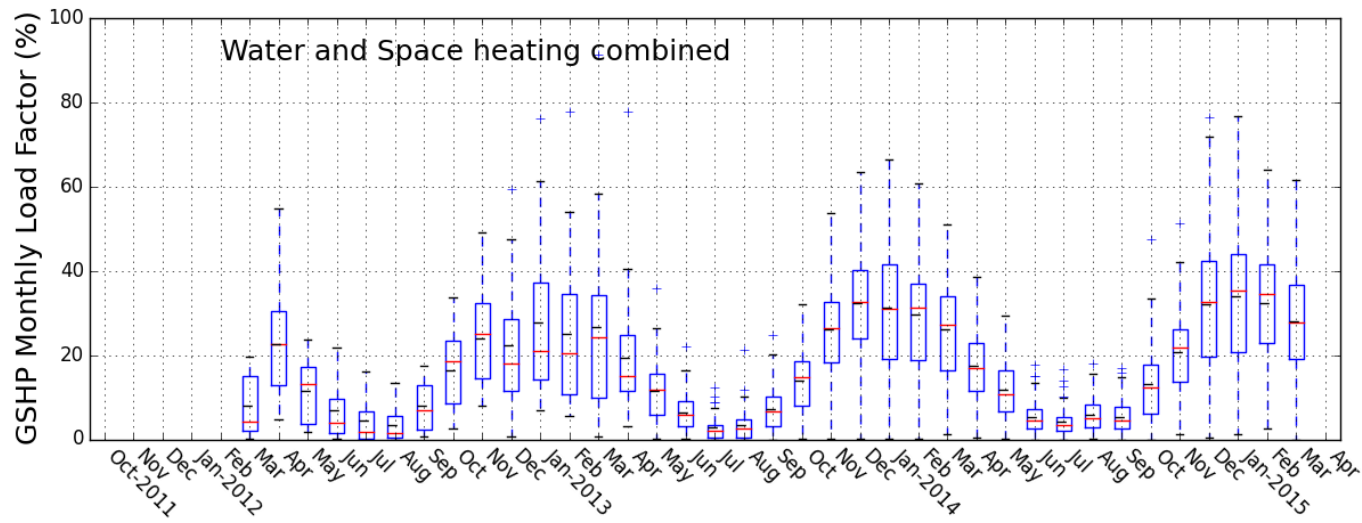
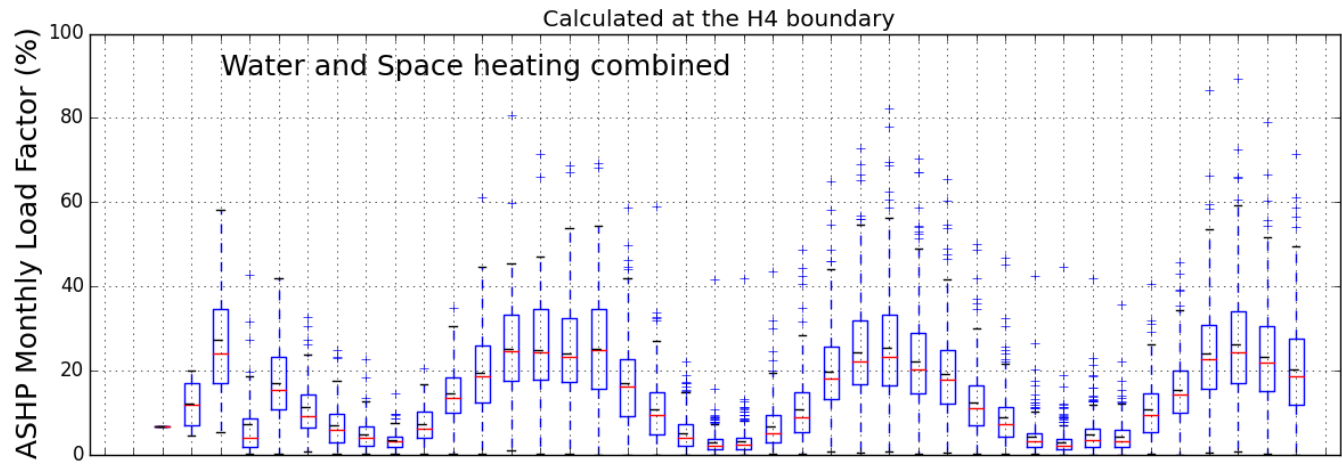


Figure 3-15. Box plots of monthly load factors at H4 system boundary for ASHPs and GSHPs.

## 4 Discussion and implications

RHPP field trial of HP systems undertaken by DECC has sufficient scale (sample size and duration), scope (range of HP systems and installation sites), and depth (high frequency monitoring data at key points across system boundaries) to provide the foundation for wide ranging technical evaluation of HP systems. The process of data quality assessment for sample selection, suggests that findings presented in this report, such as the qualitative implications from summary statistics for SPFs and other performance measures of HP systems, should be useful for policy development. Furthermore, the analysis here has shown the first steps for a more detailed description that can provide insights on heat pump operation, as well as the identification of potential issues impacting on the monitoring and performance of specific groups of ASHP and GSHP systems. The results and their implications in this report, however, need to be caveated with regard to potential systemic issues and sources of error, which include:

- For results to be generalised for the UK, the samples selected need not only to be representative of the RHPP sample (which the tests suggests is likely to be the case), but the RHPP sample must also be representative of the UK stock of HP systems. While we do not have information to check if this the case, the RHPP sample is geographically spread, includes owner occupied and social housing, and covers a range of dwelling construction types, sizes, ages and households. This suggests that the RHPP sample is broadly representative of HP systems installed under the RHPP scheme.
- The heat meters used to measure the output of heat from heat pumps in the RHPP sample were calibrated for water. In practice the heat distribution systems for a proportion of heat pumps will contain a mixture of water and antifreeze (glycol). This becomes necessary where the heat pump is sited outside the dwelling. The presence of glycol lowers the specific heat capacity and unless allowed for, will result in overestimation of the amount of heat delivered by heat pumps to the dwellings they serve. Estimates of SPF based on these heat meters will be correspondingly overestimated, by perhaps as much as 7% (corresponding to 25% ethylene glycol). Use of propylene glycol instead of ethylene glycol would reduce the effect on heat meter calibration to 4% (at a 25% concentration). Unfortunately, we do not have data on actual antifreeze concentrations at RHPP sites - additional work would be needed to confirm the types of antifreeze and their concentrations in use in the RHPP sample and to refine an estimate of the overall impact on SPF estimates.
- A separate problem with heat meters is that there appears to be a tendency for the flow rate that they record to decline over time. The magnitude of this decline is generally less than 10%, but in one case is in excess of 90% - see Appendix A. We do not know the reasons for this decline, or whether it results from calibration drift, or from an underlying decline in the flow of water from the heat pump. If the former, we may have systematically underestimated SPFs.
- Interpretation of any data relies on metadata that describes the systems under investigation. Much of the metadata that we have access to has proved unreliable. We have e.g. been unable to

trust the schematics that were provided for all sites in the trial, and have had to rely on the monitored data itself to try to establish the precise configuration of some installations. As an example, we believe we have identified some systems where, contrary to what appears in the schematic, an immersion heater is connected through the same electricity meter as the heat pump compressor, leading to potential confusion around SPF boundaries. To put this more simply, we have monitoring data, but we cannot be absolutely sure in all cases what systems that data describe.

It is intended to publish a separate document addressing systematic errors and potential effect on results in more depth.

Despite these caveats, we believe that the work presented in this report provides a firm foundation for assessing the performance of HP systems in the sample. The summary statistics, for instance  $SPF_{H4}$  of 2.30 ( $\pm 0.03$ ) and 2.75 ( $\pm 0.09$ ) for ASHPs and GSHPs in the adjusted Sample C, are consistent with previous findings in the EST Phase II field trial and the Preliminary findings, given the different circumstances of those analyses.

In the process of detailed model development for the weather adjustment using data from Sample C, which was for a relatively warm 12 months, the inclusion of weather factors other than external temperature were not found to improve the model significantly; hence the terminology for the adjustment under UKSET conditions. While the adjustment resulted in small changes to the mean SPFs (and within the statistical uncertainty), as expected the effect tended to be greater for ASHPs than for GSHPs, as the former are inherently more sensitive to external air temperatures. It is also worth noting that the mean SPFs for Sample B were in close agreement with the adjusted results for Sample C. This is consistent with the increased likelihood of more typical UK conditions for data from Sample B as these were selected from different annual periods across the length of the study (according to the most complete and consistent data available in each site). This, and the theoretical expected lack of sensitivity to modest variations in external temperature suggests that weather correction may not be critical for the evaluation of long duration studies at the aggregate level.

The results showed that on average HP systems under UKSET conditions were above the  $SPF_{H2} \geq 2.5$  boundary required for classification as a renewable energy source (mean  $SPF_{H2}$  for ASHP of 2.56 ( $\pm 0.03$ ) and 2.92 ( $\pm 0.09$ ) for GSHPs. So while 55% of ASHPs and 79% of the GSHPs can be classified as sources of renewable energy, this still leaves more than one in three ASHPs and one in five GSHPs operating below this key performance threshold and unable to contribute to targets under EU Renewable Energy Directive (European Commission, 2013b)<sup>9</sup>.

---

<sup>9</sup> European Commission, (2013b) states “Electrically driven heat pumps with an SPF of 2.5 and above, as well as thermally driven heat pumps with an SPF of 1.15 and above, should be included. Electrically driven heat pumps with an SPF below 2.5, as well as thermally driven heat pumps with an SPF below 1.15, must be excluded. It is not sufficient to judge if the national average is above this threshold — even if the national average is above this threshold the total capacity should be estimated based on the assessment of this threshold on the level of individual heat pump units.”

Nevertheless the results indicate that over 93% of sites already result in carbon savings, even when compared to gas for condensing boilers. This report calculates future CO<sub>2</sub> savings relative to a long term marginal factor supplied by DECC of 0.362 kgCO<sub>2</sub>/kWh. Further grid decarbonisation over the coming decades would simply amplify the carbon savings from HP systems (Lowe, 2007; CCC, 2008, 2013; DECC, 2015b; ETI, 2015).

The pattern of savings in fuel costs is more complex, but again the results suggest that the vast majority of sites produce bill savings compared with electricity, coal and LPG, and most produce bill savings with respect to oil. Actions to lift the performance of the lowest 25% to at least that of the current average performance, which should be achievable, would markedly increase the proportion of HP systems that produce fuel cost savings relative to natural gas.

## Next steps

This report has identified a number of avenues for potential further investigation, most of which are at least in part covered under the currently agreed programme of work and will be addressed in the next report examining the reasons for good or poor performance. Specifically:

- Analytical work is on-going in a number of areas, including regarding attempts to infer the use of electricity for boost heating where this was not directly measured (113 sites). Of these fewer than 30 appear to have some boost heating occurring, and this is minor in all but 3 sites. While this work remains important as part of the investigation into reasons for good or poor performance, such issues affecting small subsets of the sample are unlikely to impact substantively on any of the summary statistics presented.
- An important new area of investigation has emerged as part of the analysis, which concerns the progressive decline in the measurement of flow rates for the water circulation in some sites, which may indicate metering or operational problems. Further work will look at the potential implications for operational and/or monitoring of HP systems, in terms of detecting declining meter accuracy or calibration drift, the flow capacity of the pipe, as well as HP system performance over time, as part of the longer term monitoring and evaluation methods.
- A number of approaches will be examined to include as many of the over 200 sites that are currently omitted from the analysis, such as resolving some of the sites with apparently mislabelled schematics. This is likely to involve identifying practical methods of temperature adjustment of SPFs when much less than annual data is available.
- Further investigation of the potential impact of glycol antifreeze on measurement of heat where meters were calibrated for water.

This work will be complemented by case studies of approximately 20 sites based on detailed site surveys and occupant interviews, which have been underway since November 2015. These case studies will, in particular, inform our work on reasons for good and bad performance.

Detailed analysis of performance indicators can identify both design and installation issues that are invaluable evidence in driving the incremental improvements possible through technical development and refinement of HPs and their associated components, and development and refinement of training for HP system designers and installers. Furthermore, such evaluations need to consider the robustness of HP system performance with other contextual factors, such as the thermal characteristics of the building fabric and changes in occupant demands and behaviour.

## 5 References

BRE, 2013. The Government's Standard Assessment Procedure for Energy Rating of Dwellings: 2012 edition, Watford: BRE on behalf of DECC. <http://www.bre.co.uk/filelibrary/SAP/2012/SAP-20129-92.pdf>

CCC, 2008. Building a low-carbon economy – the UK's contribution to tackling climate change. TSO, London, UK.

CCC, 2013. Fourth Carbon Budget Review – technical report: Sectoral analysis of the cost-effective path to the 2050 target. London, UK.

DECC, 2014. RHI and RHPP deployment data: November 2014. see Table 3.1, Table 4.1 and Table 5.1 <https://www.gov.uk/government/statistics/rhi-and-rhpp-deployment-data-november-2014>

DECC, 2015a. Average annual domestic electricity bills by home and non-home supplier (QEP 2.2.1). <https://www.gov.uk/government/statistical-data-sets/annual-domestic-energy-price-statistics>.

DECC, 2015b. Valuation of energy use and greenhouse gas (GHG) emissions – background documentation, <https://www.gov.uk/government/publications/valuation-of-energy-use-and-greenhouse-gas-emissions-for-appraisal>. See also accompanying tables Data\_tables\_1-20\_supporting\_the\_toolkit\_and\_the\_guidance.xlsx .

DECC, 2015c. Digest of UK Energy Statistics (DUKES) 2015 Table 5D [https://www.gov.uk/government/uploads/system/uploads/attachment\\_data/file/447632/DUKES\\_2015\\_Chapter\\_5.pdf](https://www.gov.uk/government/uploads/system/uploads/attachment_data/file/447632/DUKES_2015_Chapter_5.pdf)

Dunbabin, P., & Wickins, C., 2012. Detailed analysis from the first phase of the Energy Saving Trust's heat pump field trial: Evidence to support the revision of the MCS Installer Standard MIS 3005 Issue 3.1. London: DECC. [https://www.gov.uk/government/uploads/system/uploads/attachment\\_data/file/48327/5045-heat-pump-field-trials.pdf](https://www.gov.uk/government/uploads/system/uploads/attachment_data/file/48327/5045-heat-pump-field-trials.pdf)

Dunbabin, P., Charlick, H., & Green, R., 2013. Detailed analysis from the second phase of the Energy Saving Trust's heat pump field trial. London: DECC. [https://www.gov.uk/government/uploads/system/uploads/attachment\\_data/file/225825/analysis\\_data\\_second\\_phase\\_est\\_heat\\_pump\\_field\\_trials.pdf](https://www.gov.uk/government/uploads/system/uploads/attachment_data/file/225825/analysis_data_second_phase_est_heat_pump_field_trials.pdf)

EST, 2010. Getting warmer: a field trial of heat pumps. <http://www.heatpumps.org.uk/PdfFiles/TheEnergySavingTrust-GettingWarmerAFieldTrialOfHeatPumps.pdf>

ETI, 2015. Smart Systems and Heat: Decarbonising Heat for UK Homes. Loughborough.

<http://www.eti.co.uk/wp-content/uploads/2015/03/Smart-Systems-and-Heat-Decarbonising-Heat-for-UK-Homes-.pdf>

European Commission, 2009a. Directive 2009/28/EC of the European Parliament and of the Council of 23 April 2009 on the promotion of the use of energy from renewable sources and amending and subsequently repealing Directives 2001/77/EC and 2003/30/EC.

European Commission, 2009b. Directive 2009/28/EC of the European Parliament and of the Council of 21 October 2009 establishing a framework for the setting of ecodesign requirements for energy-related products.

European Commission, 2013a. Establishing the guidelines for Member States on calculating renewable energy from heat pumps from different heat pump technologies pursuant to Article 5 of Directive 2009/28/EC of the European Parliament and of the Council.

European Commission, 2013b. European Commission Eurostat, Directorate E: Sectoral and regional statistics, Unit E-5: Energy, SHARES Tool Manual, Version 2013.50204.

Fuka, Daniel R., M. Todd Walter, Charlotte MacAlister, Arthur T. Degaetano, Tammo S. Steenhuis, and Zachary M. Easton. 2014. Using the Climate Forecast System Reanalysis as weather input data for watershed models. *Hydrological Processes* 28 (22) 5613-5623.

Gleeson, C.P., Lowe, R., 2013. Meta-analysis of European heat pump field trial efficiencies. *Energy and Buildings* 66, 637–647. doi:10.1016/j.enbuild.2013.07.064

IPCC, 2014. Fifth Assessment Report (AR5). <https://www.ipcc.ch/report/ar5/>

Lowe, R., 2007. Technical options and strategies for decarbonizing UK housing. *Building research and information* 35, 412–425.

Meteorological Office, 2014. Winter 2013/14 - assessment of the weather experienced across the UK during Winter 2013/2014 and how it compares with the 1981 to 2010 average [WWW Document]. URL <http://www.metoffice.gov.uk/climate/uk/summaries/2014/winter> (accessed 3.31.15).

Miara, M., Günther, D., Kramer, T., Oltersdorf, T., Wapler, J., 2011. Wärmepumpen Effizienz - Messtechnische Untersuchung von Wärmepumpenanlagen zur Analyse und Bewertung der Effizienz im realen Betrieb. Fraunhofer-Institut für Solare Energiesysteme ISE, Freiburg. (Heat pump efficiency - measurement study of heat pump systems for the analysis and assessment of the effectiveness in the real operation). Fraunhofer-Institute for Solar Energy Systems. [http://wp-effizienz.ise.fraunhofer.de/download/wp\\_effizienz\\_endbericht\\_kurzfassung.pdf](http://wp-effizienz.ise.fraunhofer.de/download/wp_effizienz_endbericht_kurzfassung.pdf)

Orr, G., Lelyveld, T. & Burton, S., 2009. Final Report: In-situ monitoring of efficiencies of condensing boilers and use of secondary heating. Gastec for EST.

[https://www.gov.uk/government/uploads/system/uploads/attachment\\_data/file/180950/In-situ\\_monitoring\\_of\\_condensing\\_boilers\\_final\\_report.pdf](https://www.gov.uk/government/uploads/system/uploads/attachment_data/file/180950/In-situ_monitoring_of_condensing_boilers_final_report.pdf)

Palmer J. & Cooper, I., 2013. United Kingdom housing energy fact file 2013.

[https://www.gov.uk/government/uploads/system/uploads/attachment\\_data/file/345141/uk\\_housing\\_fact\\_file\\_2013.pdf](https://www.gov.uk/government/uploads/system/uploads/attachment_data/file/345141/uk_housing_fact_file_2013.pdf)

Refaeilzadeh, P., Tang, L. & Liu, H., 2009. Cross-Validation, Encyclopedia of Database Systems, Springer, pp532-538.

Riviere, A., Coevoet, M., Tran, C., Zottl, A., Nordman, R., 2011. D4.2. / D 3. 4 . Concept for evaluation of SPF - Version 2.0 - A defined methodology for calculation of the seasonal performance factor and a definition which devices of the system have to be included in this calculation: Air to air heat pumps.

[https://ec.europa.eu/energy/intelligent/projects/sites/ice-projects/files/projects/documents/sepemo-build\\_concept\\_for\\_evaluation\\_of\\_spf\\_for\\_hydronic\\_hps\\_en.pdf](https://ec.europa.eu/energy/intelligent/projects/sites/ice-projects/files/projects/documents/sepemo-build_concept_for_evaluation_of_spf_for_hydronic_hps_en.pdf)

Saha, S., et al. 2011 (updated monthly). NCEP Climate Forecast System Version 2 (CFSv2) Selected Hourly Time-Series Products. Research Data Archive at the National Center for Atmospheric Research, Computational and Information Systems Laboratory. <http://rda.ucar.edu/datasets/ds094.1/> . Accessed 25/06/2015.

Sharp, E., Dodds, P., Barrett, M. & Spataru, C., 2015. Evaluating the accuracy of CFSR reanalysis hourly wind speed forecasts for the UK, using in situ measurements and geographical information. Renewable Energy 77 (2015): 527-538.

Wickins, C., 2014. Preliminary report on the Renewable Heat Premium Payment metering programme. London: DECC.

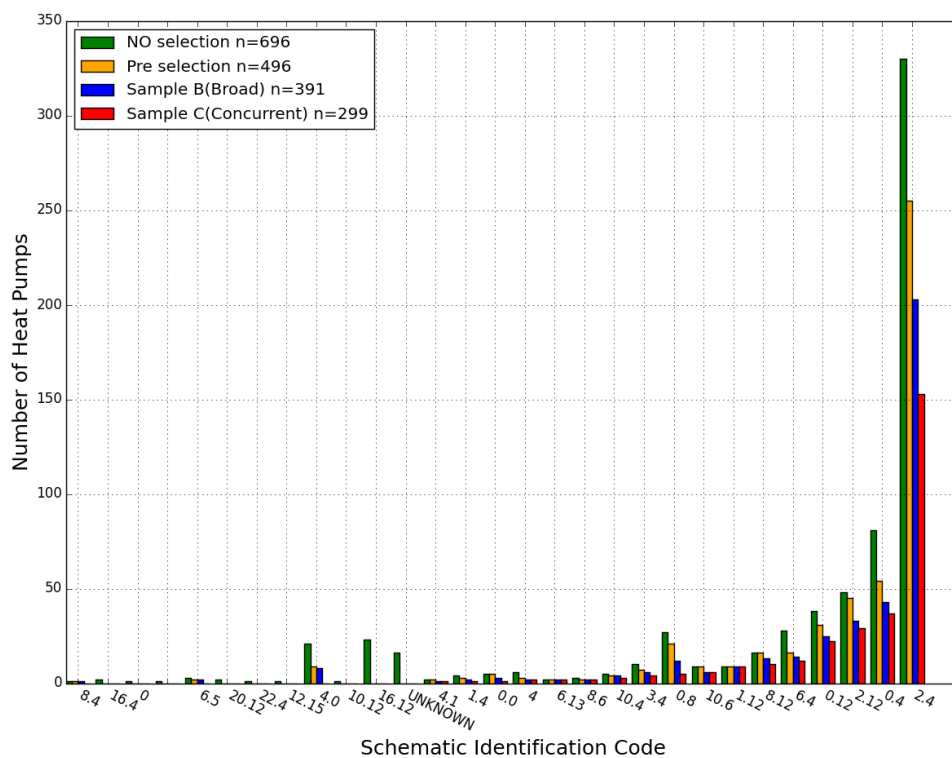
[https://www.gov.uk/government/uploads/system/uploads/attachment\\_data/file/276612/Preliminary\\_Report\\_on\\_the\\_RHPP\\_metering\\_programme\\_2014-01-31.pdf](https://www.gov.uk/government/uploads/system/uploads/attachment_data/file/276612/Preliminary_Report_on_the_RHPP_metering_programme_2014-01-31.pdf)



## Appendix A: Stability of performance indicators over time.

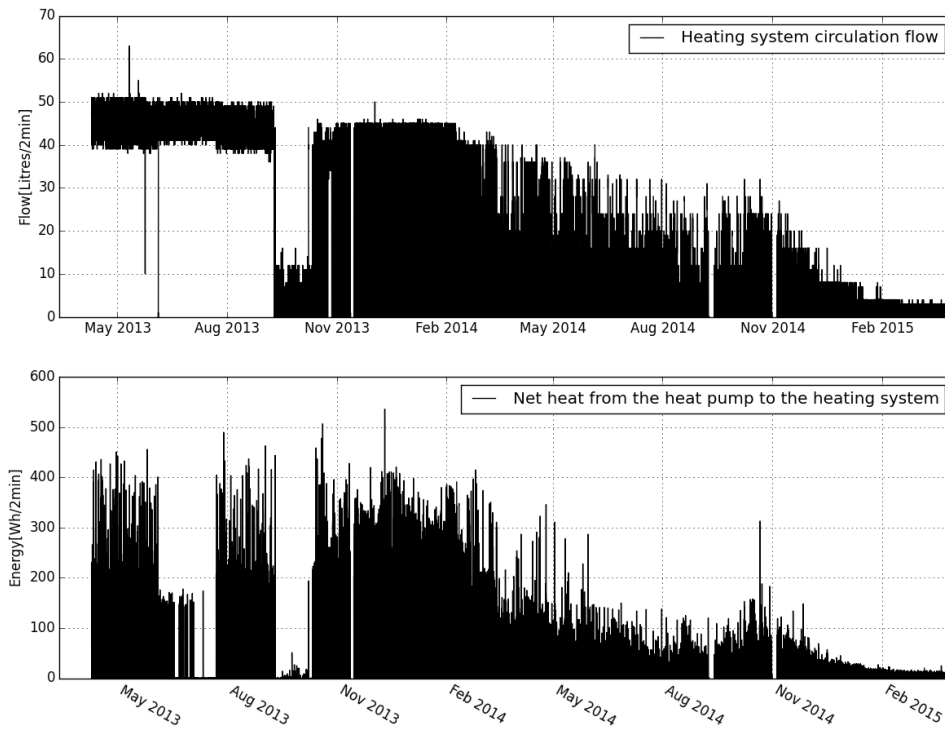
Since the selection Sample B and Sample C, and the subsequent adjustment to UKSET conditions represent a major update in methodological terms, this appendix presents some the checks undertaken to assess issues that may have arisen during the selection and/or adjustment process.

Comparison of the prevalence of each the schematics in the Sample B and Sample C (Figure A-1), as well as of the received database (described here as No selection) suggests that there is an appropriately broad representation of the main measurement configurations used in the study.

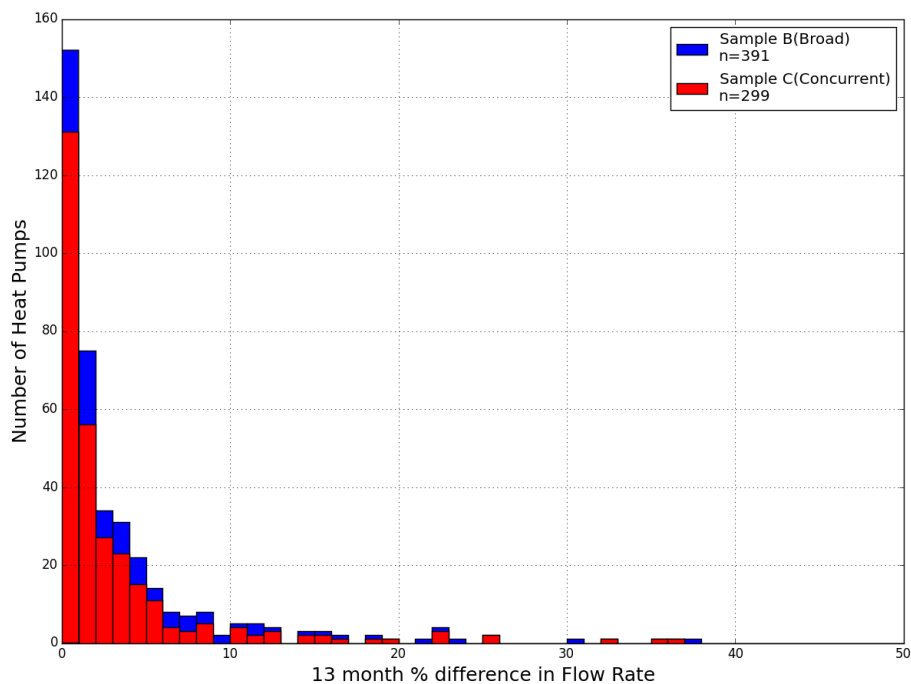


**Figure A-1. Representation of each schematic after selection of sites for each of the samples, compared with the initial RHPP sample (ranked by schemes in Sample C)**

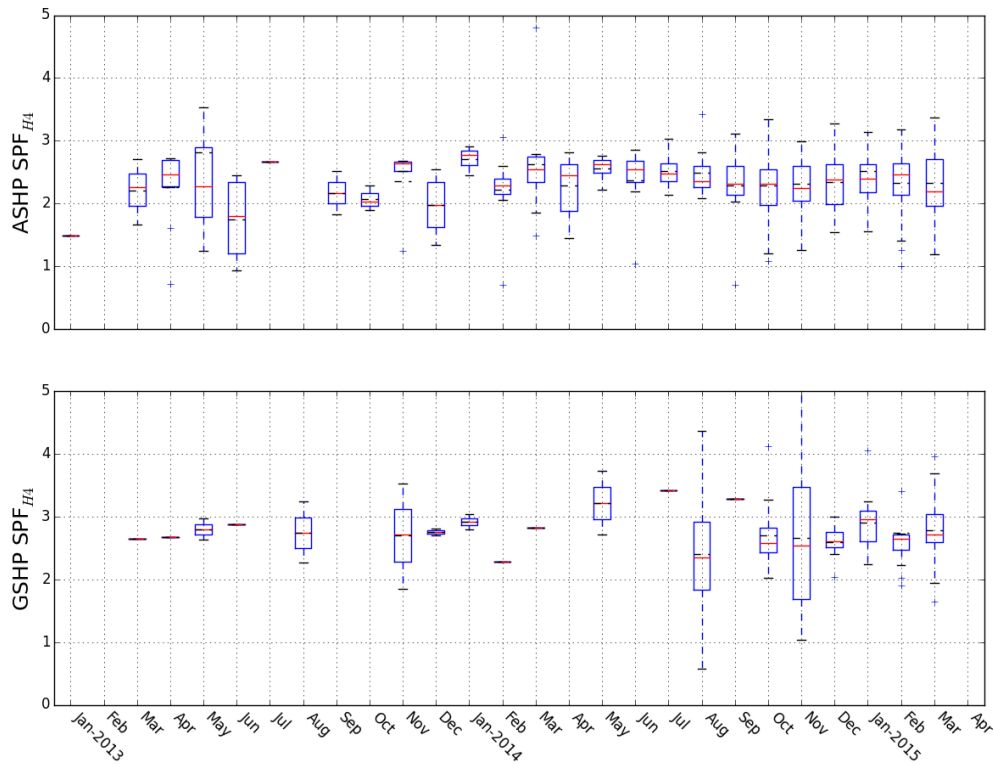
Figure A-2 provides an (extreme) example of the progressive decline over time in water circulation flow rates which formed the rationale for selection of the annual period (actually 13 months) of sufficiently complete data that had the least decline (and hence most stable circulation) in the calculation of SPFs. Figure A-3 shows the result of this selection process, with the vast majority of sites having less than 10% decline. This issue warrants further investigation however, as it could indicate operational or metering issues over time.



**Figure A-2. An example site where the circulation flow rate progressively declined over the monitoring period**



**Figure A-3. The percentage difference in circulation flow rates between the 1<sup>st</sup> and 13<sup>th</sup> month, where these are the minimum such difference and were the basis for that 13 month period being selected for sites in Sample C**



**Figure A-4. Sample B sites with  $SPF_{H4}$  over time (note the  $SPF_{H4}$  is an annual efficiency obtained for each Site plotted at the last month of data used)**

Figure A-4 shows extent that the distribution of  $SPF_{H4}$  varies over time, with no indication of a systematic change over time (though some variability due to the annual variation in weather conditions would be expected). The distributions for GSHPs have small sample sizes, hence greater variation would be expected from month to month.

Figure A-5 shows the result of this adjustment to UKSET conditions, with GSHPs remaining largely unchanged and the ASHPs having slightly lower SPFs, with around 5% of ASHPs having an adjustment of 20% or more (though these sites tended to be shifted in both directions).

Figures A-6 and A-7 show histograms overlapping closely for the three samples, without evidence of the introduction of bias in the selection and analytical process.

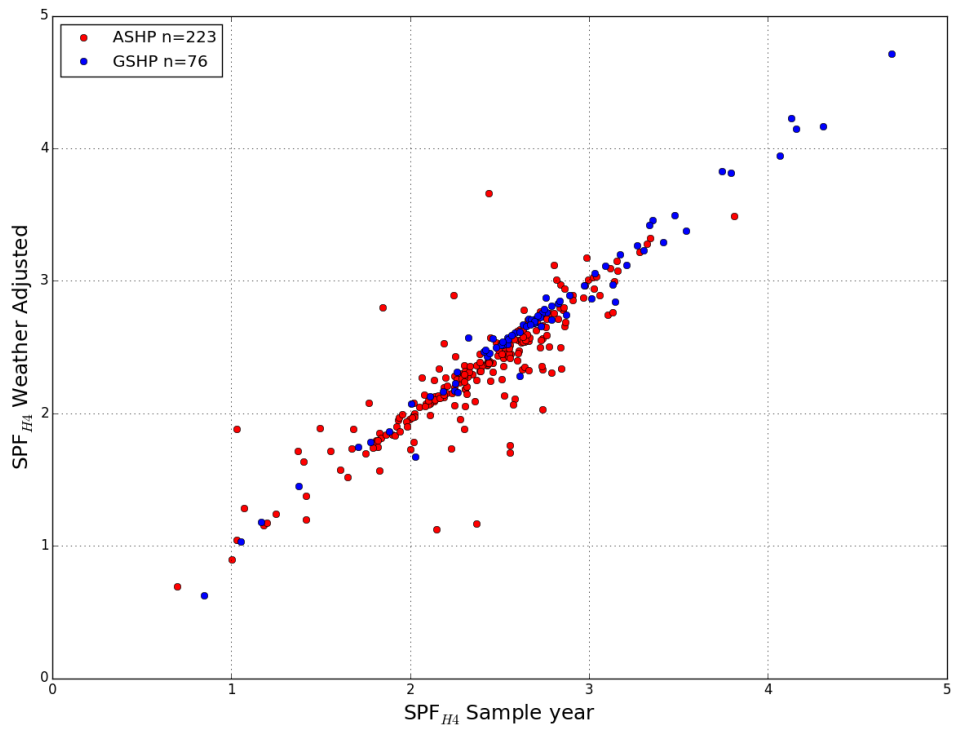


Figure A-5. Scatter plot comparing  $SPF_{H4}$  from sites in Sample C with the corresponding adjusted values under UKSET conditions (where ASHPs are shown in red, GSHPs in blue)

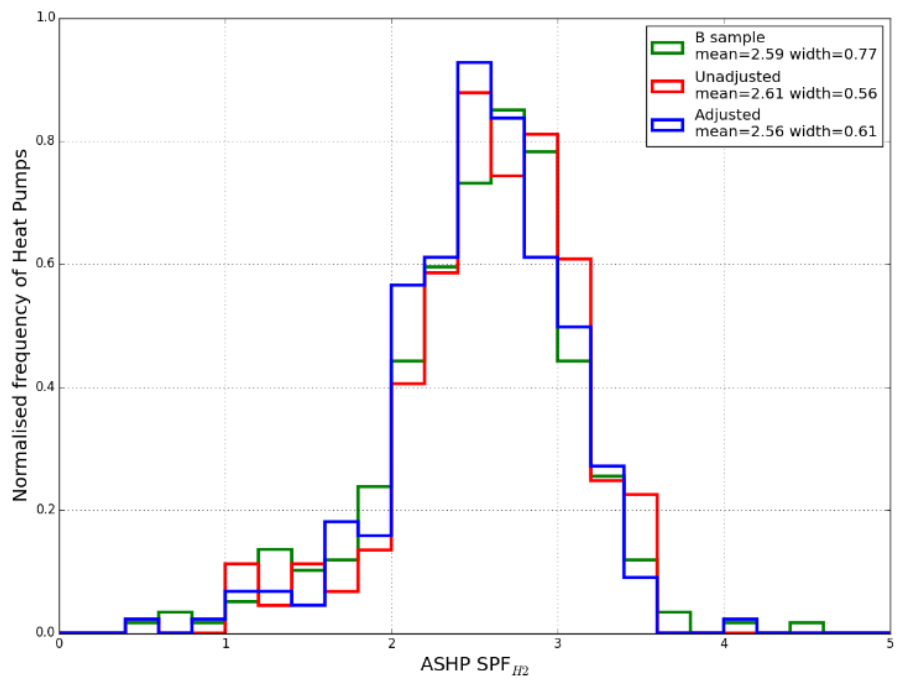
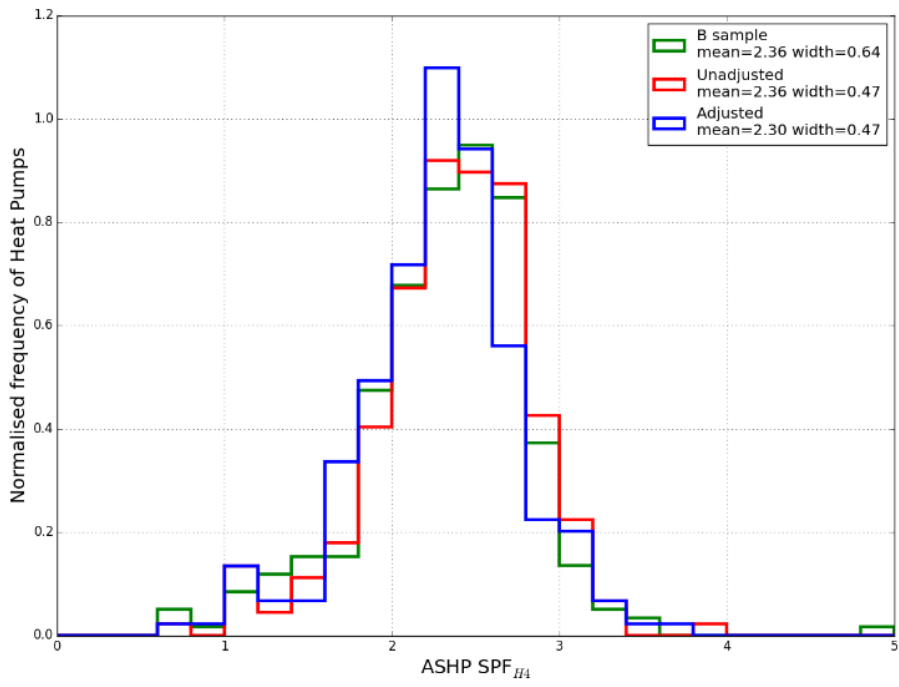
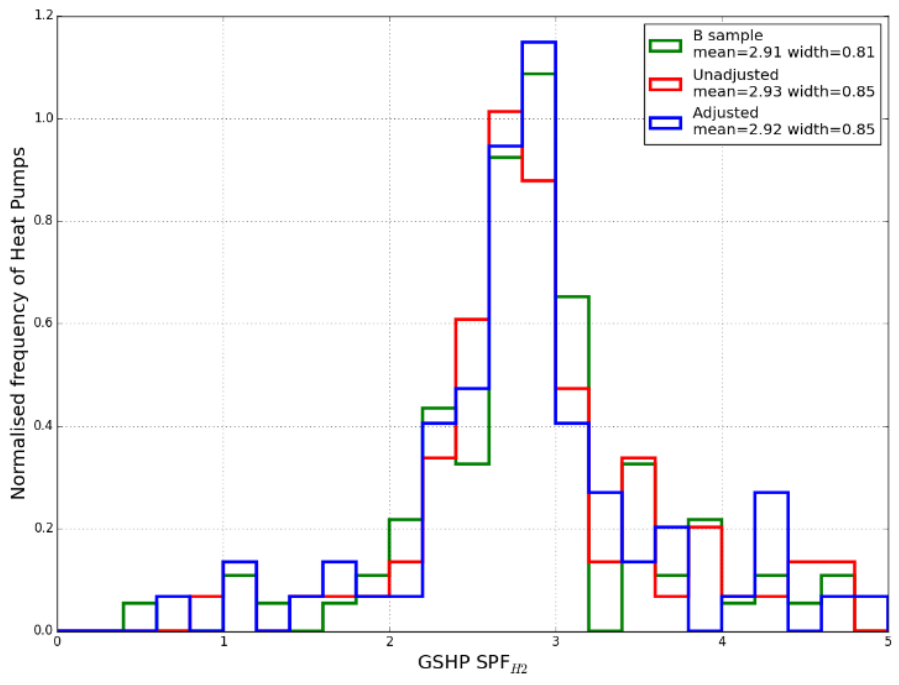


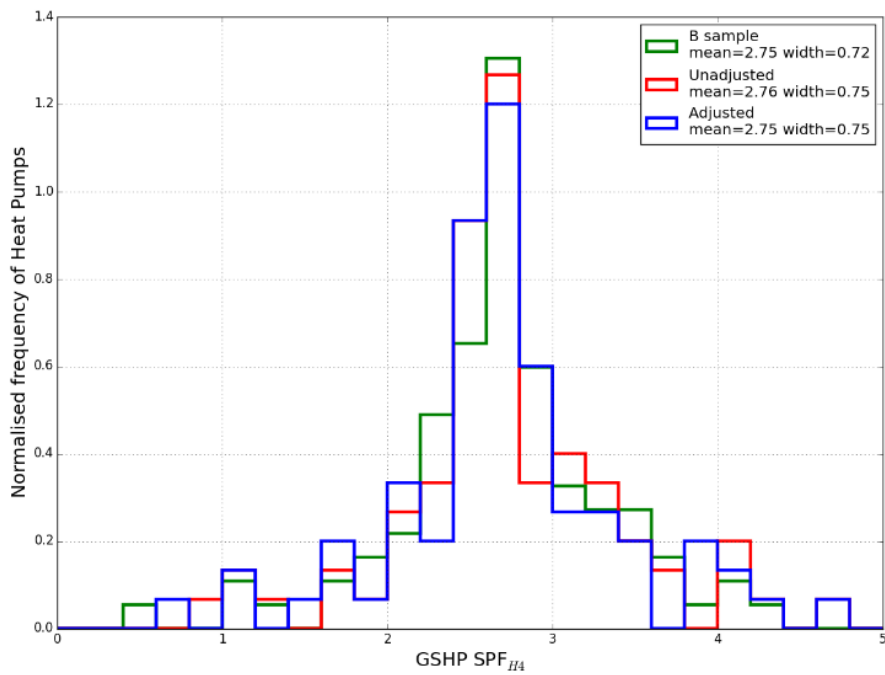
Figure A-6. Histograms of  $SPF_{H2}$  for ASHPs in Sample B (green), Sample C unadjusted (red) and Sample C adjusted to UKSET conditions (blue)



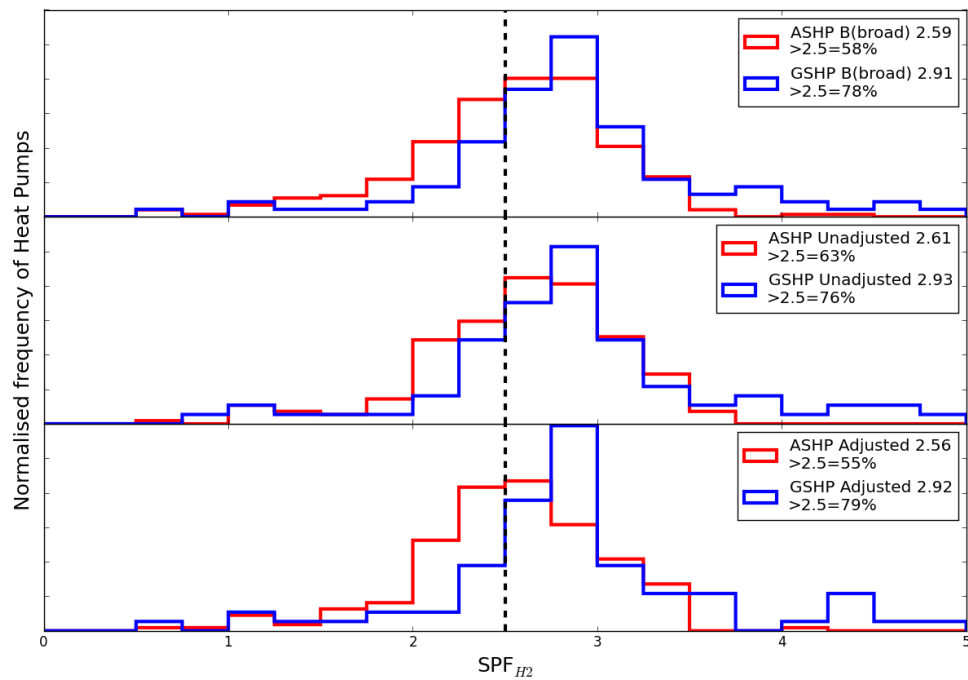
**Figure A-7. Histograms of  $SPF_{H4}$  for ASHPs in Sample B (green), Sample C unadjusted (red) and Sample C adjusted to UKSET conditions (blue)**



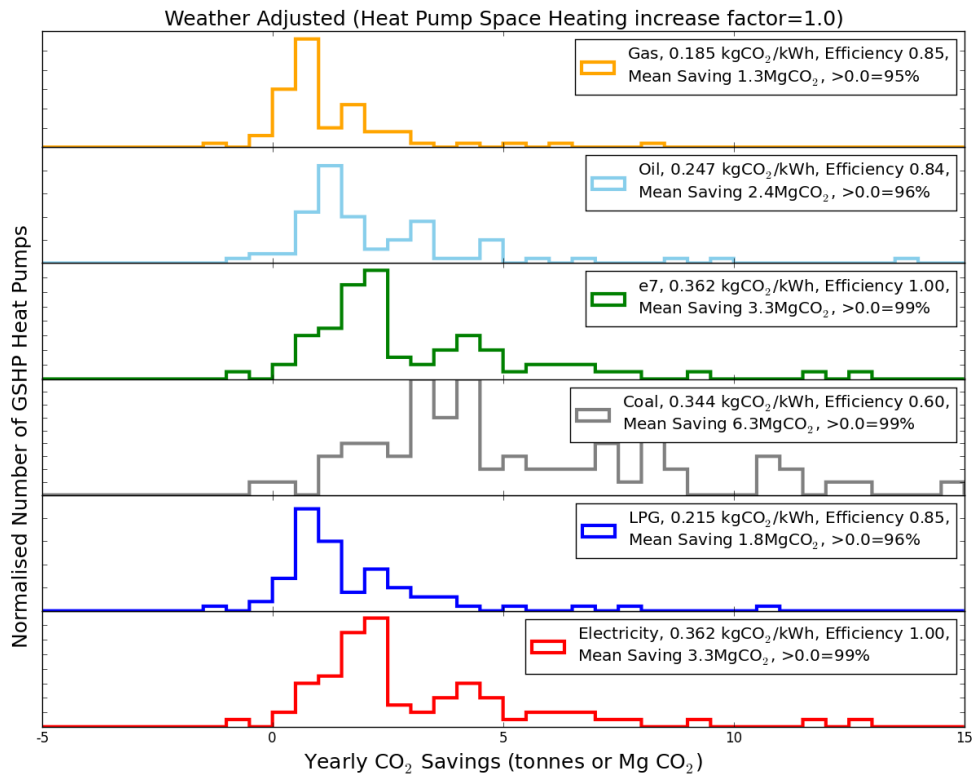
**Figure A-8. Histograms of  $SPF_{H2}$  for GSHPs in Sample B (green), Sample C unadjusted (red) and Sample C adjusted to UKSET conditions (blue)**



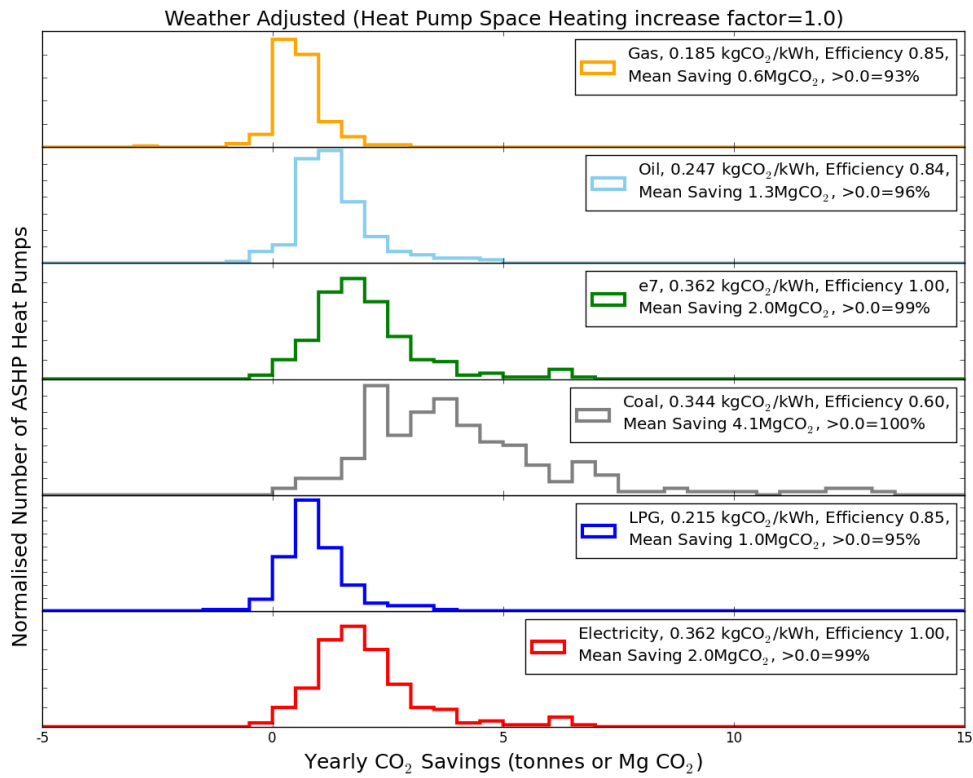
**Figure A-9. Histograms of  $SPF_{H4}$  for GSHPs in Sample B (green), Sample C unadjusted (red) and Sample C adjusted to UKSET conditions (blue)**



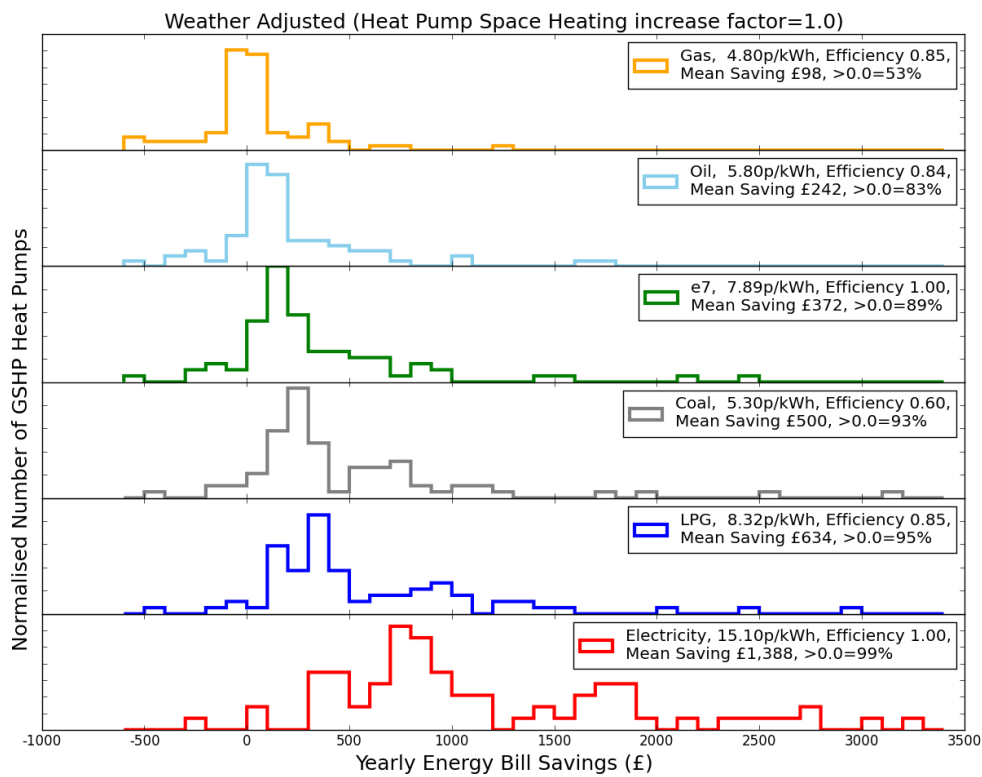
**Figure A-10. Histograms for ASHPs and GSHPs with the  $SPF_{H2} \geq 2.5$  renewable energy boundary for Sample B (top), Sample C unadjusted (middle) and Sample C adjusted to UKSET conditions (bottom)**



**Figure A-11. Histograms of annual CO<sub>2</sub> savings for GSHPs when replacing gas, oil, electricity (E7), Coal, LPG, and Electricity (standard tariff) with data from Sample C adjusted to UKSET**

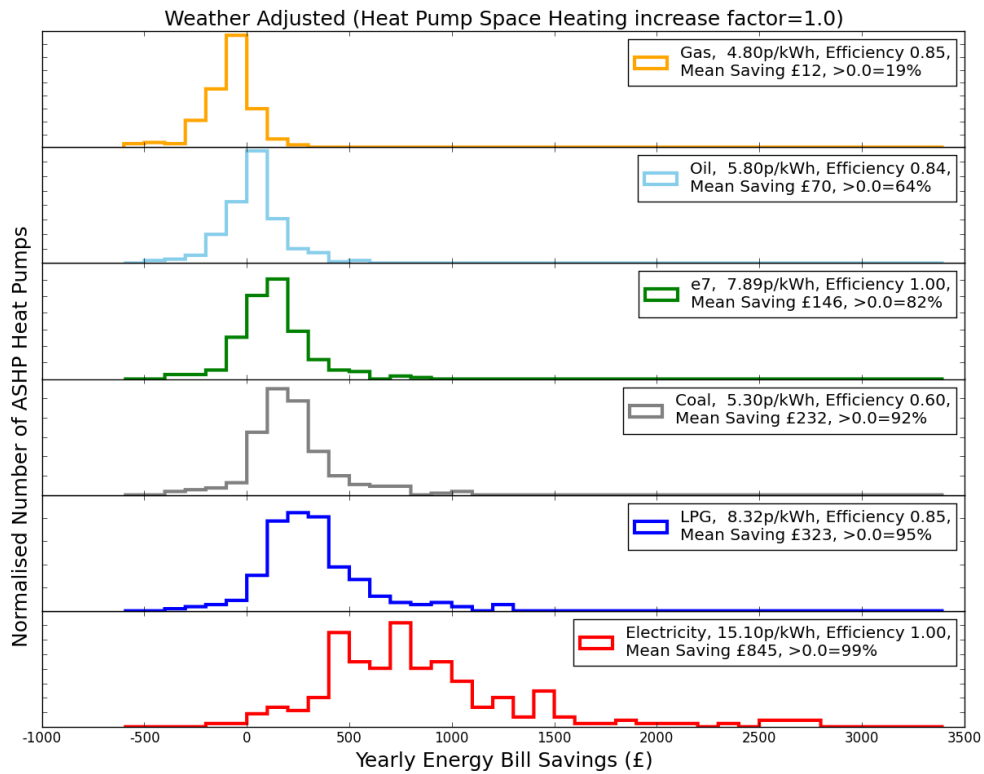


**Figure A-12. Histograms of annual CO<sub>2</sub> savings for ASHPs when replacing gas, oil, electricity (E7), Coal, LPG, and Electricity (standard tariff) with data from Sample C adjusted to UKSET**

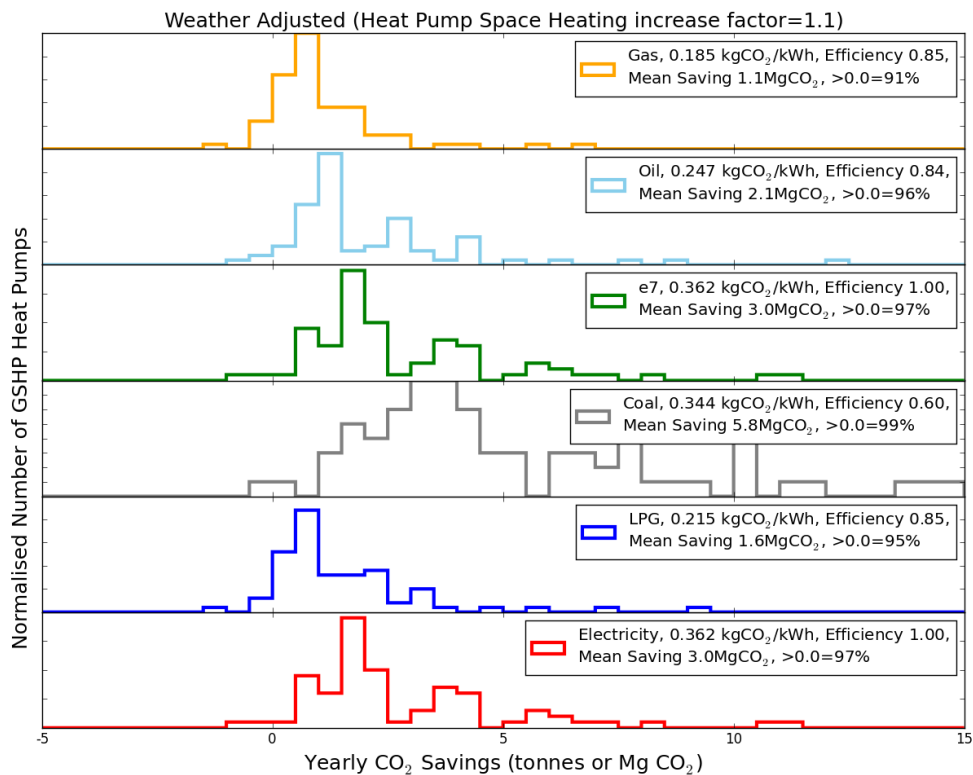


**Figure A-13. Histograms of mean annual fuel cost savings (£) for GSHPs when replacing gas, oil, electricity (E7), Coal, LPG, and Electricity (standard tariff) with data from Sample C adjusted to UKSET**

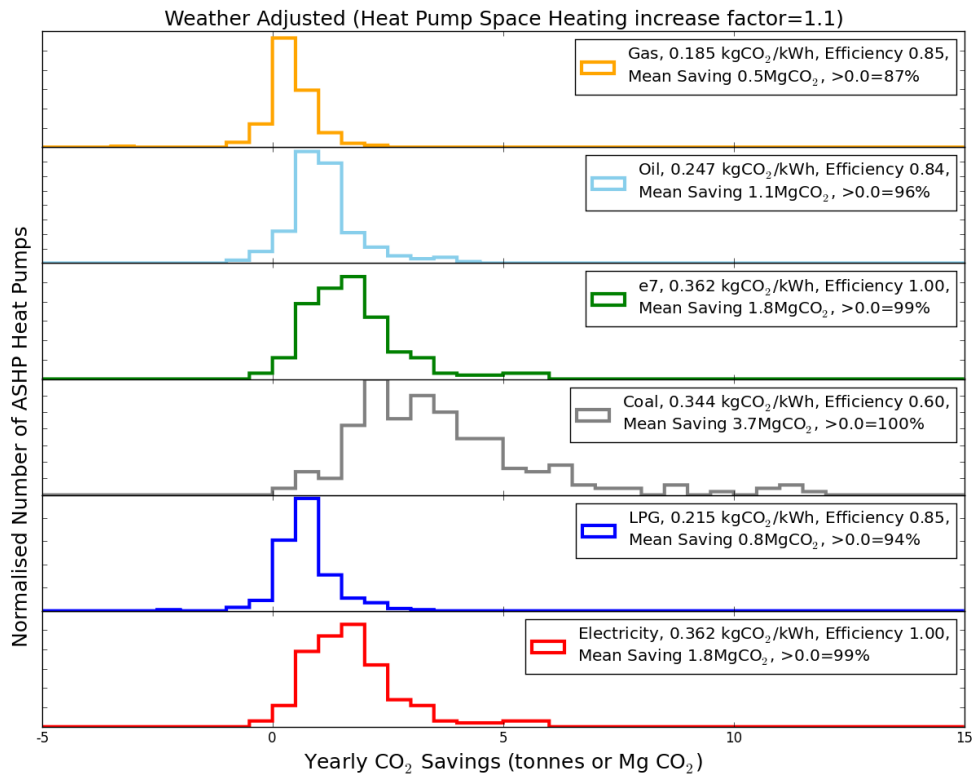




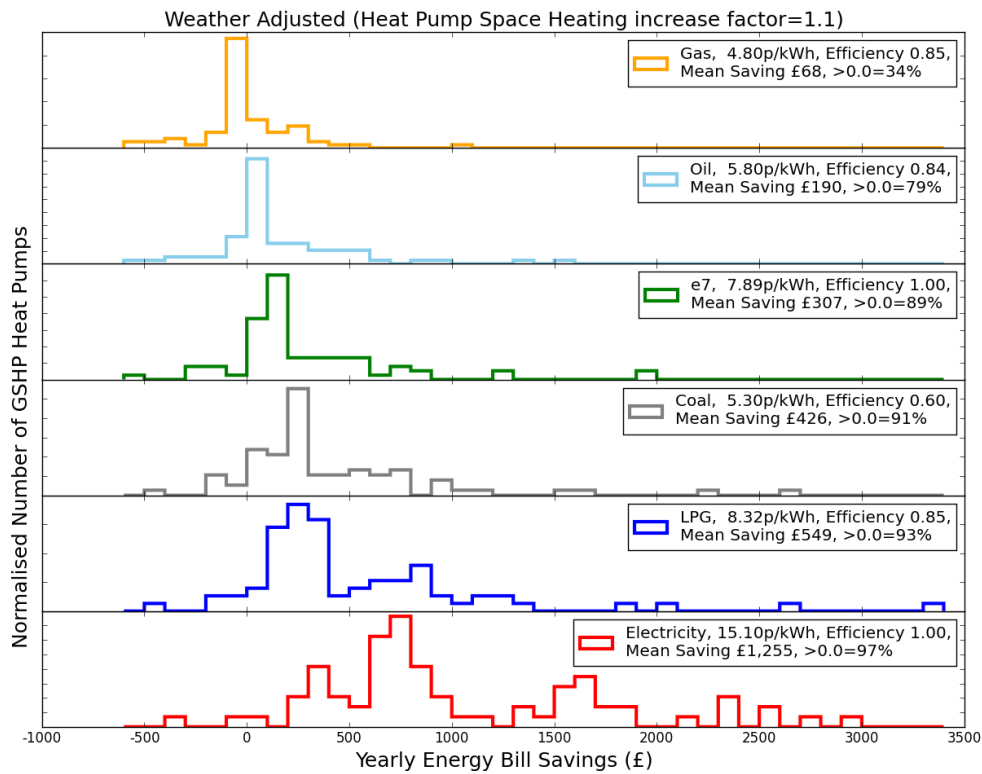
**Figure A-14. Histograms of mean annual fuel cost savings (£) for ASHPs when replacing gas, oil, electricity (E7), Coal, LPG, and Electricity (standard tariff) with data from Sample C adjusted to UKSET**



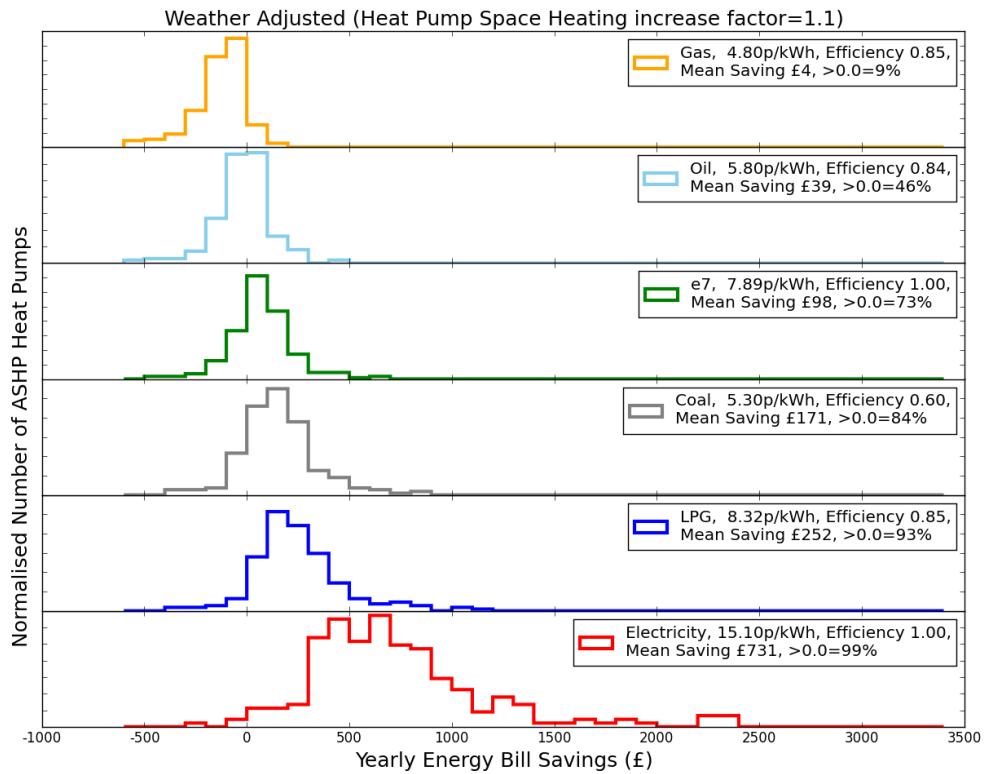
**Figure A-15. Histograms of annual CO<sub>2</sub> savings for GSHPs under the CO<sub>2</sub> +10% scenario of increased space heating when replacing gas, oil, electricity (E7), Coal, LPG, and Electricity (standard tariff) with data from Sample C adjusted to UKSET**



**Figure A-16. Histograms of annual CO<sub>2</sub> savings for ASHPs under the CO<sub>2</sub> +10% scenario of increased space heating when replacing gas, oil, electricity (E7), Coal, LPG, and Electricity (standard tariff) with data from Sample C adjusted to UKSET**



**Figure A-17. Histograms of mean annual fuel cost savings (£) for GSHPs under the CO<sub>2</sub> +10% scenario of increased space heating when replacing gas, oil, electricity (E7), Coal, LPG, and Electricity (standard tariff) with data from Sample C adjusted to UKSET**



**Figure A-18. Histograms of mean annual fuel cost savings (£) for ASHPs under the CO<sub>2</sub> +10% scenario of increased space heating when replacing gas, oil, electricity (E7), Coal, LPG, and Electricity (standard tariff) with data from Sample C adjusted to UKSET**

## Appendix B: Data and calculation issues

This Appendix details various issues that have arisen as part of the data analysis process and the approach that has been adopted to resolve them.

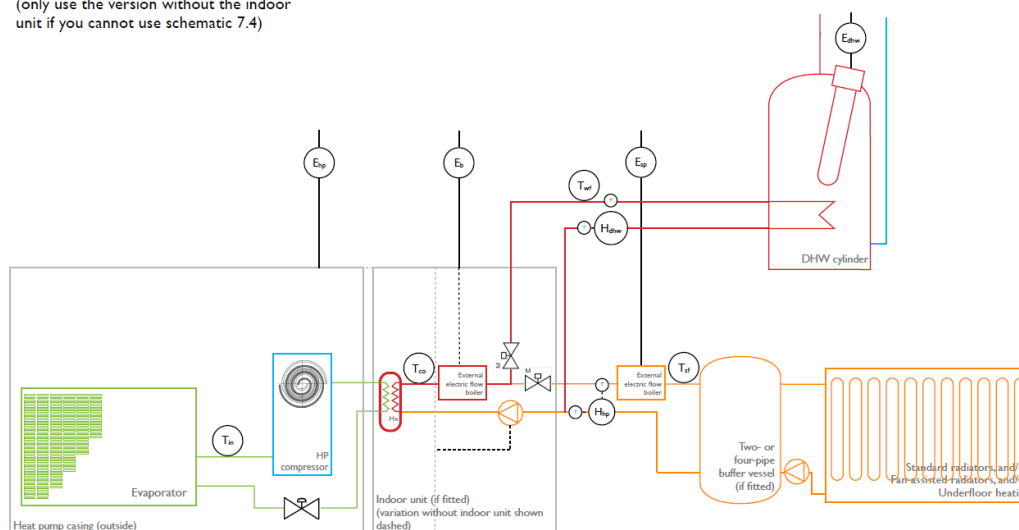
### B.1 Identifying Immersion Heater Electricity Use

During the course of analysing the RHPP data, it has become apparent that there were problems with the identification of which electricity meters were monitoring which variables. There are up to four electricity meters that might be installed:

1. Ehp is the main meter that measures the supply to the heat pump unit. This is the only meter that is installed at all sites.
2. Eboost, if installed, measures the supply to a separately powered boost heater, located upstream of the heat meter(s).
3. Edhw, if installed, measures the supply to any hot water cylinder immersion heater.
4. Esp, if installed, measures the supply to any space heat only boost heater.

Figure B 1 shows a system schematic for a heat pump with all four electricity meters installed. Note that this system also has two heat meters installed (Hhp and Hdhw) which measure space heating and hot water separately. Most sites only have one heat meter installed (Hhp) to measure both space heating and hot water.

Schematic 15.4  
Air-source system providing SH and DHW  
(only use the version without the indoor  
unit if you cannot use schematic 7.4)



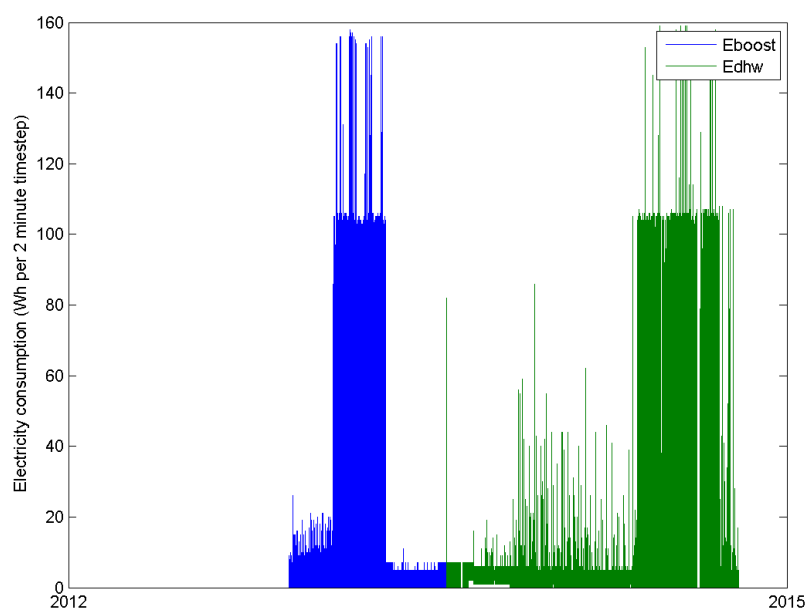
Issue 2.1 (13/09/2012)

84

**Figure B 1. Schematic of heat pump system with all four possible electricity meters installed.**

During the course of the monitoring programme, various ‘interventions’ were required, for example replacing faulty sensors, replacing batteries, etc. It appears that at several sites the electricity meters were initially connected to the wrong inputs on the data logger, in particular it seems a common mistake was connecting the Edhw meter to the Eboost input so that it appeared as though the immersion heater was in fact a booster heater. These installation mistakes were corrected where identified, however it appears that the data files received by Rapid-HPC on 10<sup>th</sup> December, were not corrected. This results in data that looks like Figure B 2 where the data stream ‘switches over’ from one channel to another – at first Eboost records data and Edhw records zeros, then Edhw records data and Eboost records zeros. This is problematic as it then appears to the analysis routines as if there is both a booster heater (which operates at the beginning of the monitored period) and an immersion heater (which operates at the end of the monitored period).

The distinction between Eboost and Edhw is important because as noted above, and shown in Figure B 2 the booster heater is located on the heat pump side of the heat meter(s), and so the heat output from that heater is included in the heat measured by the heat meter, whilst the immersion heater (and Esp if present) are located on the house side of the heat meter, and so their heat output is not included in the heat measured by the heat meter and must be added on when calculating  $SPF_{H4}$ .



**Figure B 2. Monitored Eboost & Edhw for sites RHPP5745.**

Further analysis revealed instances where Edhw was noted as incorrectly connected to Eboost, but not corrected on site (for example RHPP5121 where the audit report identifies that Edhw is incorrectly connected), so that Edhw appears on the Eboost channel throughout the monitored period.

An analysis routine was therefore written to detect which channels were connected and reporting data. This is made slightly complicated as it appears that channels with no meters attached can still periodically produce readings (presumably due to the radio interference problem previously identified in the Data

Quality report (RAPID-HPC, 2015). We have therefore defined a meter to be connected when it produces more than a minimum number of non-zero readings (initially this has been set to 20 readings) and when these readings are spread over a period of more than one week. This definition is heuristic and is based on manual inspection of the recorded data. The risk of throwing away useful data is minimal, since the analysis time step is two minutes there are 262,800 data points per year, and a sensor that genuinely produces only 19 non-zero readings will not have a visible impact on the final results.

‘Channel switchovers’ can then be detected by comparing pairs of connected channels and looking for pairs where the period of monitored data does not overlap. All pairs of electricity meter channels were compared, and four instances of channel switchover in the data were identified, three from Eboost to Edhw and one from Edhw to Ehp (Table B 1).

**Table B 1. Instances of ‘channel switchover’**

Affected site	Channel switchover
<b>RHPP5268</b>	Edhw->Ehp
<b>RHPP5447</b>	Eboost->Edhw
<b>RHPP5711</b>	Eboost->Edhw
<b>RHPP5745</b>	Eboost->Edhw

We then compared the meters that are reporting to the meters that we expect to be reporting based on the declared monitored schematic ID.

This identified 27 sites where Eboost was reporting and Edhw was not, but where Edhw was expected and Eboost was not, based on the declared monitoring schematic (Table B 2) (for some of these systems there is no note in the interventions log that Edhw was misconnected).

A further six sites were identified where Eboost reports in addition to Edhw, but where Edhw was expected and Eboost was not based on the declared monitoring schematic (Table B 3). For three of these cases Eboost starts recording a small energy consumption towards the end of the monitored period (of the order 10Wh per two minute time step, or 30W). This data does not look ‘sensible’ but it’s not known how it might have arisen (and maybe related to batteries running down). The level recorded is small and so will have minimal impact on the results. For one site Eboost exactly duplicates Edhw, for one site Eboost and Edhw record only a very small energy consumption throughout and for one site Edhw records data at the beginning of the monitored period, which almost matches Eboost, and then stops reporting data.

**Table B 2. Sites where Eboost reports instead of Edhw**

Affected site
RHPP5121
RHPP5162
RHPP5185
RHPP5223
RHPP5281
RHPP5286
RHPP5347
RHPP5370
RHPP5405
RHPP5407
RHPP5433
RHPP5463
RHPP5485
RHPP5493
RHPP5509
RHPP5560
RHPP5608
RHPP5620
RHPP5634
RHPP5649
RHPP5665
RHPP5709
RHPP5713
RHPP5778
RHPP5782
RHPP5784
RHPP5798

**Table B 3. Sites where Eboost reports in addition to Edhw**

Affected site	Notes
<b>RHPP5196</b>	Period at end of monitoring where Eboost starts recording small values
<b>RHPP5291</b>	Eboost & Edhw combined account for 0.4% of the total electricity use, so safe to ignore
<b>RHPP5335</b>	Eboost duplicates Edhw
<b>RHPP5571</b>	Period at end of monitoring where Eboost starts recording small values
<b>RHPP5575</b>	Edhw records at beginning of data (almost matching Eboost) then stops
<b>RHPP5797</b>	Period at end of monitoring where Eboost starts recording small values

The 36 heat pumps identified in Table B 1, Table B 2, and Table B 3 are flagged as having possibly misidentified Edhw as Eboost. The manufacturer and model number was then used (where available) to determine whether or not a boost heater was likely to be installed in any of these flagged systems. In 30 out of the 36 cases it was determined that a boost heater was unlikely based on the manufacturer’s specifications. In five cases it was not possible to say anything about the presence of a booster heater. One of the 36 systems (RHPP5711) is a Daikin Altherma system, which has a built-in booster heater. This is one of the ‘switch over’ systems from Table B 1, where Eboost reports for only a relatively short period at the beginning of the data. Given that the booster heater is built in it seems unlikely that it would be separately metered.

There are 28 sites where Eboost is expected to be monitored. Analysis of the data from these sites shows that over the period monitored for each site, Eboost is non-zero at only three sites, and that it is no more than 0.4% of Ehp for those sites, in other words the booster heater electricity consumption is small compared to the total. This is in contrast to systems where Edhw is expected to be monitored and where no Eboost data is present (136 sites), where total Edhw can be almost any magnitude compared to Ehp.

We have therefore taken the approach that if a system unexpectedly has data for Eboost and has no data for Edhw, then we reallocate the Eboost data to the Edhw channel. For many of the affected systems we are confident that this is correct, based on manual verification of the heat pump model. For the remaining systems, we believe that if Eboost is actually recording a boost heater (i.e. that the declared schematic is incorrect), then its energy use should be small and so the effect on the final results small (as mentioned above, where Eboost is separately monitored, it is no more than 0.4% of Ehp).

In general, transferring Eboost to Edhw will tend to increase the calculated heat outputs and SPFs as the electricity consumption remains the same but total heat output increases. The heat from an internal boost is measured at the heat meter whereas the heat from an immersion is unmeasured but is assumed to be



the same as the electricity input. Therefore we are comparing  $SPF = H_{hp}/(E_{hp}+E_b)$  with  $SPF = (H_{hp}+H_{dhw})/(E_{hp}+E_{dhw})$ .

Simplified example: Consider a system in which  $H_{hp}=100$ ,  $E_{hp}=20$ ,  $E_b=5$ ; the result is that  $SPF=100/(20+5)=4$  which, when boost is reassigned as immersion, becomes  $(100+5)/(20+5) = 4.2$

## B.2 Incorrect Declared Monitoring Schematic

The previous section detailed 36 systems where Eboost is unexpectedly reporting but where we believe that it is in fact data for Edhw based on the declared monitoring schematic. Several further unexpected meters have been identified:

- Two sites have been identified where Eboost is reporting but neither Eboost nor Edhw are expected (RHPP5324 & RHPP5521).
- Four sites have been identified where Edhw is unexpectedly reporting
- Two sites have been identified where Esp is unexpectedly reporting
- 18 sites have been identified where a separate heat meter for the hot water output is reporting but should not be installed according to the schematic.

This leads us to believe that the declared monitoring schematic is incorrect for 22 sites in total. It is not possible to exactly determine the schematic for these sites, but that is not necessary in order to conduct the analysis and these sites have not been removed from the analysis dataset.

There are eight sites for which the monitoring schematic is not declared, for these sites the schematic has been inferred from the measured data.

Note that we cannot detect instances where a meter should be installed but isn't, because in the monitored data this is identical to a meter that is installed but connected to a heater that is never used. There may therefore be more incorrect monitoring schematics.

The fact that the declared monitoring schematic might be wrong potentially complicates some of the evidence used in support of reallocation of some Eboost readings to Edhw, however as discussed above, we believe that if a boost heater is installed it should operate infrequently.

## B.3 Temperature Sensor Offsets

Three temperature sensors are installed on the demand side circuit at each site (see Figure B 2 for an example schematic, a fourth temperature sensor  $T_{in}$  is attached to the refrigerant circuit):

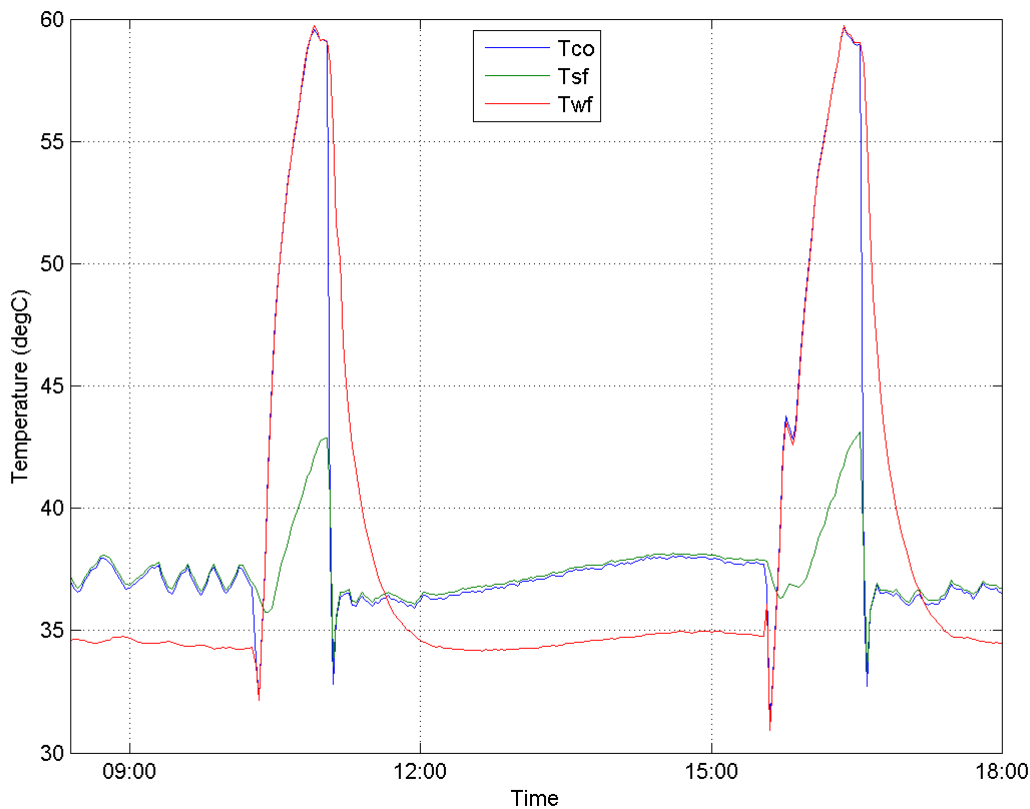
1.  $T_{co}$ , measures the temperature of the heating circuit fluid at outlet from the heat pump condenser, upstream of any booster heaters (internal or external).

2.  $T_{sf}$  measures the temperature of the heating circuit fluid at entry to the space heating circuit, downstream of any booster heaters.
3.  $T_{wf}$  measures the temperature of the heating circuit fluid at entry to the water heating circuit, downstream of any booster heaters.

For most sites the heat pump operating mode (space heating or water heating) is not directly monitored<sup>10</sup> (a small number of sites have separate heat meters for the space and water heating circuits), however in the absence of any booster heaters, either  $T_{sf}$  or  $T_{wf}$  should be very close to  $T_{co}$ . A relatively small heat loss between  $T_{co}$  and  $T_{sf}$  or  $T_{wf}$  may be expected if they are not physically close to each other (though if they are very close to each other conduction along the pipework can cause issues). In periods when the heating fluid is circulating the operating mode can in principle be determined by looking for which of  $T_{sf}$  and  $T_{wf}$  are closest to  $T_{co}$ . For example Figure B 3 shows a period of monitored temperatures for site RHPP5529 (a Mitsubishi Ecodan system with no booster heater).  $T_{co}$  is closely tracked by either  $T_{sf}$  or  $T_{wf}$ , making it clear which heating circuit is active: a water heating cycle clearly begins at around 10:30 and around 15:30. The sharp drops in temperature at the start of the water heating cycles are likely due to cold water that has been sitting in the hot water system pipework being pulled through the system once the diverter valve switches to the hot water circuit. Likewise the sharp drops at the end of the water heating cycle are likely due to the opposite effect of cooler water from the space heating circuit being drawn through the system.

---

<sup>10</sup> It is common for systems to be designed such that they produce either space heating or hot water at any given moment, however it is possible either by design or due to degradation of the diverter valve for the heat pump produce both space heating and hot water simultaneously.

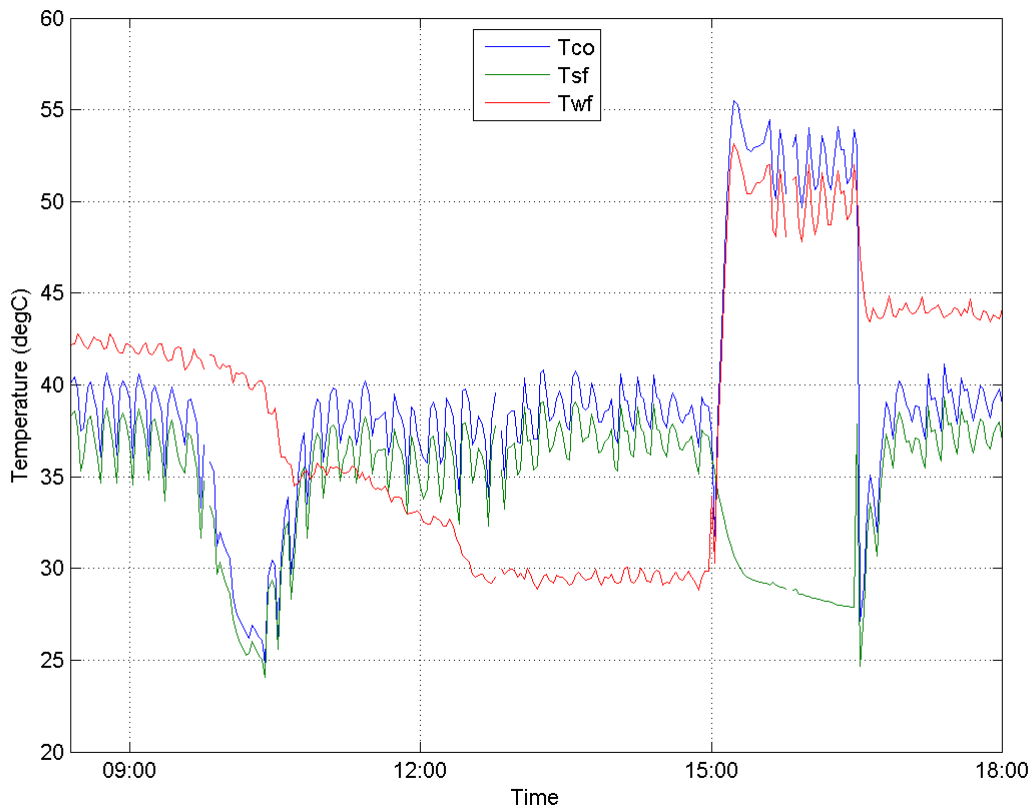


**Figure B 3. Monitored temperatures for site RHPP5529 for a period on 6<sup>th</sup> January 2014.**

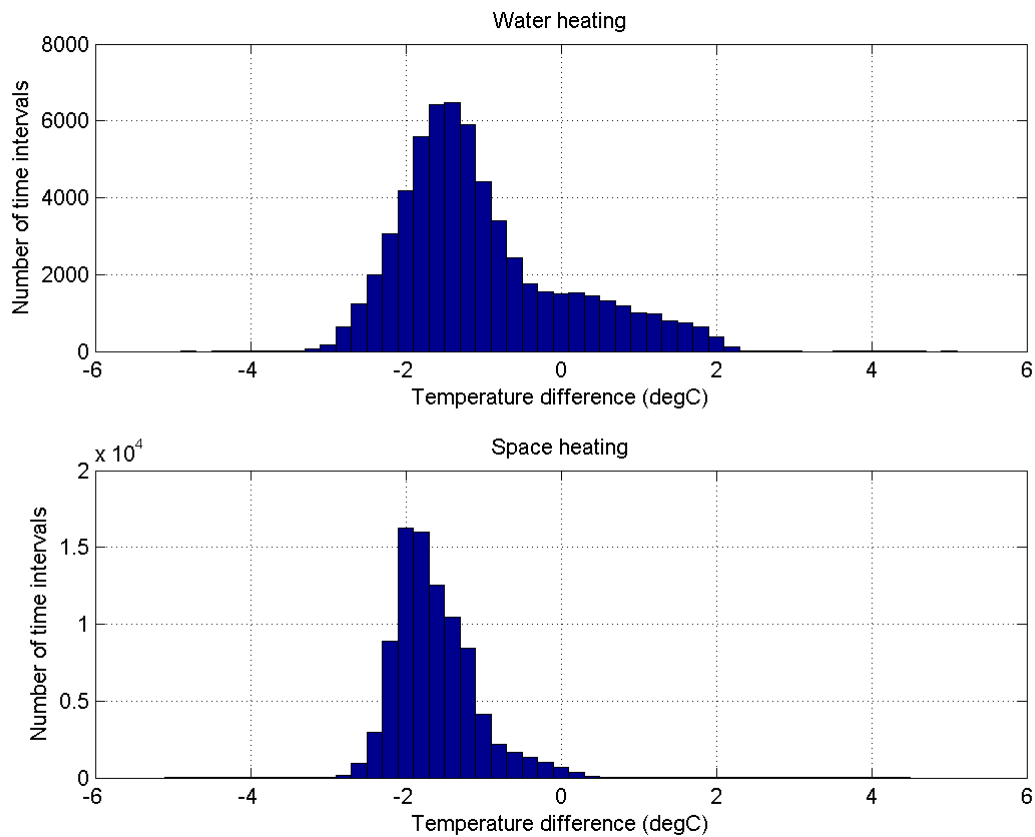
If there is a booster heater present then Tsf or Twf would be expected to be larger than Tco (in most arrangements the booster heater is likely to be for space heating mode only). With a typical heating circuit mass flow rate of 0.25kg/s, a 3kW booster heater would result in an approximately 3°C temperature rise between Tco and Tsf or Twf. In principal the operation of a built-in booster heater which is not separately monitored (such as for the Daikin Altherma mentioned previously) could be deduced from the temperature data by looking for periods where e.g. Tsf is tracking the pattern of Tco but is a small number of degrees warmer than Tco (but note that in the case of variable speed circulation pumps this temperature difference will vary depending on the system flow rate).

Initial observations of the temperature data showed that there was a fairly consistent offset between some pairs of upstream and downstream sensors. For example Figure B 4 shows the three temperature sensors for dwelling RHPP5805, another Mitsubishi Ecodan system with no booster heater. It is clear that Tco is offset from both Tsf and Twf. Figure B 5 shows a histogram of the temperature difference when the heat pump is in space heating or water heating mode (a positive value indicates a temperature rise from upstream to downstream), where operating mode is determined as described above by looking at which of Tsf or Twf is closest to Tco. Time intervals where neither Tsf nor Twf are within 5°C of Tco are ignored. The temperature offset appears to be slightly different for space and water heating mode. The histogram for temperature difference in water heating mode hints at bimodality with the longer tail on the right hand side of the peak. This might indicate something about booster heater operation though this would be surprising as it is thought that this particular system is not thought to include a booster heater –

though it should be noted that this is inferred only from looking at the product name, the presence or absence of a booster heater was not explicitly recorded as part of the monitoring installation process). The reasons for the sharp drop in Twf around 10:30 and 12:30 are unknown – the temperature data suggests that the system was in space heating mode at these times and so no water should be passing through the hot water system pipework. Perhaps a cold water supply pipe passes close to this pipe.



**Figure B 4. Monitored temperatures for site RHPP5805 for a period on 6<sup>th</sup> January 2014.**



**Figure B 5. Histogram of temperature change from upstream to downstream sensors for dwelling RHPP5805**

This data could be explained by a heat loss between  $T_{co}$  and  $T_{sf}$  or  $T_{wf}$  – perhaps there is a long external pipe run between  $T_{co}$  and  $T_{sf}$  or  $T_{wf}$ . However there are other sites which do not have booster heaters where  $T_{co}$  is consistently lower than  $T_{sf}$  and  $T_{wf}$ . It's not clear what could cause such a consistent temperature rise – conduction from the hot water or other heat sources might contribute to this, or perhaps one sensor is located inside the dwelling and one is located outside. It may also be due to the location of the sensors<sup>11</sup> on the pipework – perhaps the layout of the pipework is such that one sensor is adjacent to a region of turbulence or stagnant fluid. An alternative explanation is that these differences are caused by the calibration accuracy of the individual sensors as installed, as unlike the temperature sensors for the heat meters which are carefully paired, these sensors are unlikely to have been finely calibrated (if the individual sensor calibration accuracy is  $\pm 1^\circ\text{C}$  it is entirely plausible to have a  $2^\circ\text{C}$  temperature difference between two sensors).

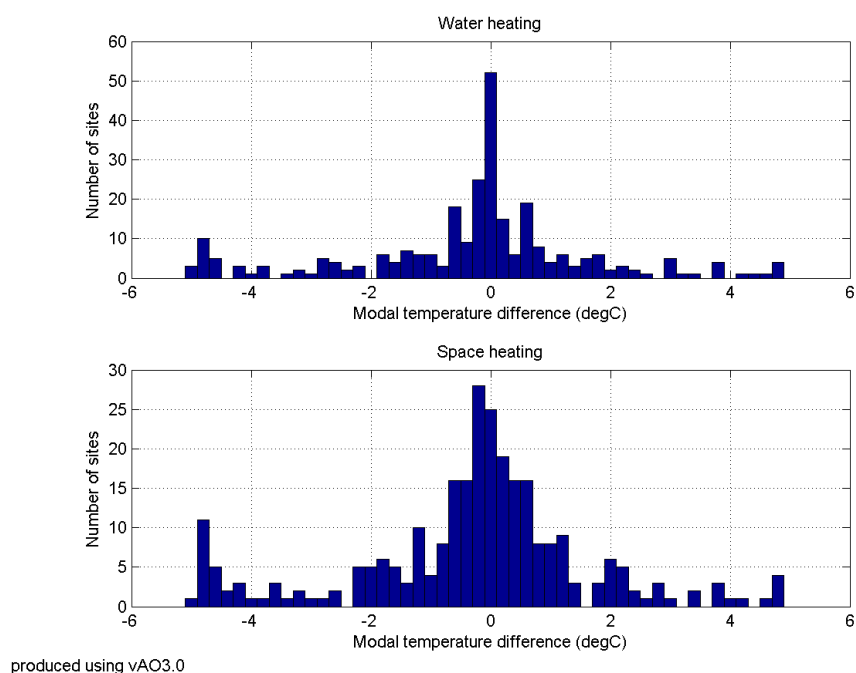
Figure B 6 shows the distribution of the modal temperature difference across sites for which there is no separately metered booster heater – i.e. the peak value has been taken from the equivalent of Figure B 5 for each of 270 sites. 43 sites have a modal temperature difference between upstream and downstream space heating temperatures of less than  $-2^\circ\text{C}$ , 19 sites have a difference of greater than  $2^\circ\text{C}$ .

<sup>11</sup> These temperature sensors were fitted to the outside of the pipe using jubilee clips rather than in the fluid flow.

These temperature offsets are not particularly problematic in identifying the heat pump operating mode, however given that the offsets between upstream and downstream temperature sensors are of the same order of magnitude as the expected temperature rise due to a booster heater, it is unlikely that the heat input to an unmonitored booster heater can be sensibly calculated from the temperature data – given the expected infrequency of booster heater operation, the real electricity consumption would be much smaller than the error caused by a continuous offset in the temperatures. For the purposes of this report we have therefore ignored unmonitored booster heaters (which is consistent with the Preliminary Assessment analysis). Given that the electricity consumption of directly monitored booster heaters has been found to be small, we expect that the electricity consumption of any unmonitored heater will also be small.

An alternative to using the temperature data is to attempt to identify boost heater use from the heat pump electricity consumption. There are two potential signals in the data: the electricity use should increase by, say, 1-3kW when the heater switches on, and the SPF should decrease towards unity. Analysis of 113 sites that could, potentially, have had unmonitored boost electricity has indicated that fewer than 30 do, and that the effect on estimates of  $SPF_{H2}$  is small in most cases.

In future heat pump monitoring studies it might be beneficial to record the heat pump power factor, as a booster heater switching on should change this noticeably (an electrical heater will have a power factor or around 1, a compressor will have a power factor of around 0.4).



**Figure B 6. Modal temperature difference for all sites without separately monitored booster heaters.**

## B.4 Circulation pump power consumption

The circulation pump energy consumption affects the calculated SPFs, heat output and electricity consumption at system boundaries H3 & H2. With the introduction in 2013 of increasingly stringent standards for circulation pumps through ECO design guidelines (European Commission, 2009b), power

consumption of new circulation pumps is likely to decrease significantly as installers move to variable control. This energy consumption is not separately metered in the RHPP dataset – in some cases the circulation pump is integrated into the heat pump unit making direct measurement impossible – and so must be estimated in order to calculate performance at the various system boundaries.

Initial analysis of the metadata shows that circulation pump power is poorly understood, especially in the light of the energy using products (EuP) Directive for electrical goods that has driven the market change to variable speed pumps with motor redesign (European Commission, 2009b). Metadata contains pump power and pump setting information on both old and new pump types, however, installers appear to be unfamiliar with “pump power” since its relation to pressure and flow is unclear to them. Much of the information is presented as a description, whether the pump name, its code, its range of pumping power, or as variations on “unknown”. Of the 703 installations<sup>12</sup>, only 451 provide unambiguous information on the number of pumps installed, Table B 4. Information on pump speed setting is provided for just 344 installations. An initial analysis of unfiltered circulation pump metadata for 703 installations is shown in Table B 4, Table B 5, Table B 6 and Figure B 7.

The metadata provides pumping power values ranging from 15 to 435 Watts per installation with a mean of 91 Watts and a median of 75 Watts, Figure B 7. Analysing pump power by percentage of the metadata shows that all systems with at least 1% of the sample lie between 20 and 220 Watts and 66% of systems are less than 100 Watts.

**Table B 4. Summary of number of heating system circulation pump/s installed provided in metadata**

Number of pumps installed	Number
1	358
2	86
3	7
<b>TOTAL</b>	451
<b>TOTAL Number of heat pumps in the metadata</b>	703

<sup>12</sup> The RHPP metering database provides metadata for 703 datasets. However Matlab data files have been provided to RAPID-HPC for 699 sites.

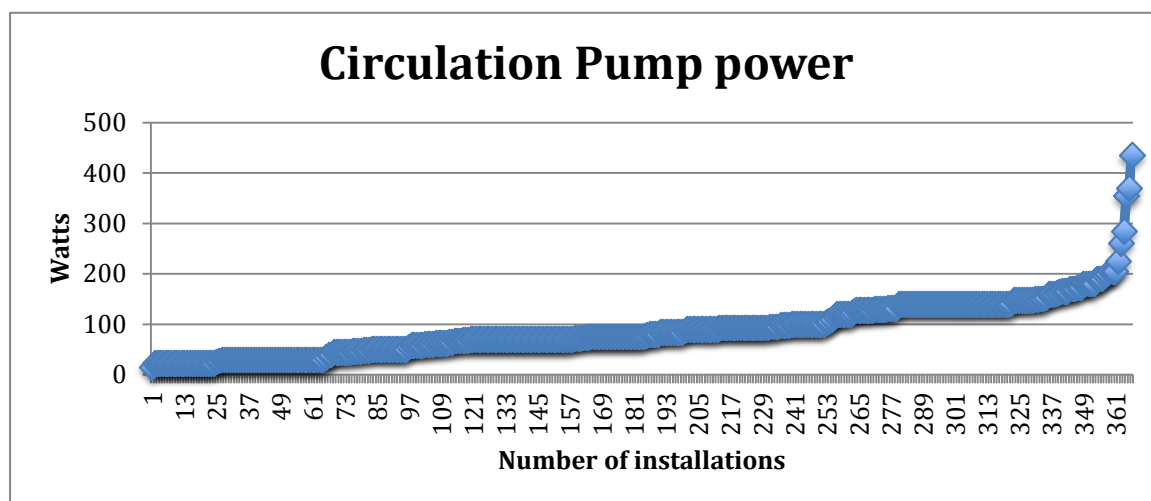
**Table B 5. Summary of pump speed settings for heating system circulation pumps provided in metadata**

<b>Speed setting</b>	<b>Number</b>
1	4
2	89
3	224
4	1
5	1
6	1
7	1
“Variable” or “auto”	23
“not known”, “N/A” or “TBC”	177
<b>TOTAL</b>	<b>521</b>
<b>TOTAL Number of heat pumps in the metadata</b>	<b>703</b>



**Table B 6. Summary of circulation pump power settings for installations provided in metadata**

Pump power (Watts)	Percentage of sample
≤ 39	18%
≤ 59	10%
≤ 79	23%
≤ 99	15%
≤ 119	5%
≤ 139	6%
≤ 159	15%
≤ 179	3%
≤ 199	2%
≤ 219	1%

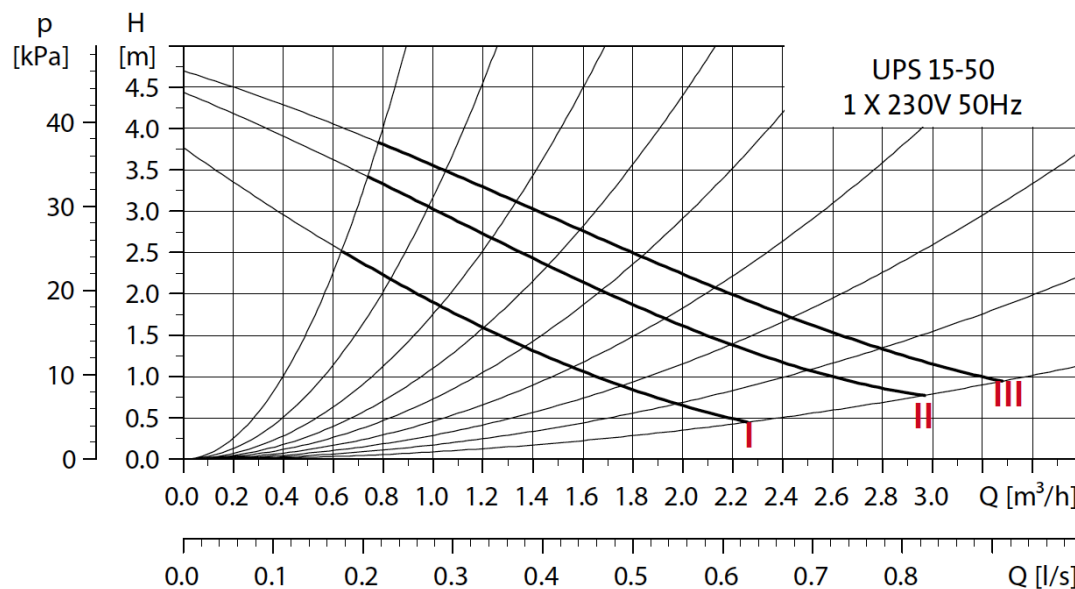


**Figure B 7. Summary of installation circulation pump power provided in the metadata**

Values for variable power, associated with variable speed pumps, is provided for 31 systems and ranges from 3 – 43 Watts to 3 - 78 Watts per pump.

In order to explore the potential challenges to calculating pump energy consumption it is worth considering a single manufacturer’s range of domestic circulation pump. Of the 344 installations providing speed settings many are from the Grundfos range as would be expected in the UK. These are labelled either as “Grundfos” or use Grundfos catalogue designations such as, 15-50, 15-60, ALPHA, 25-40, etc.

Grundfos make 3 types of pump that appear in the metadata; the fixed speed UPS and two new pumps with variable speed the ALPHA and the MAGNA. The ALPHA is the direct replacement for the UPS whereas the MAGNA is designed for commercial systems, although the lower pressure units will work with larger domestic installations. The pump curves for the UPS and ALPHA are presented in Figure B 8, Figure B 9 and Figure B 10.

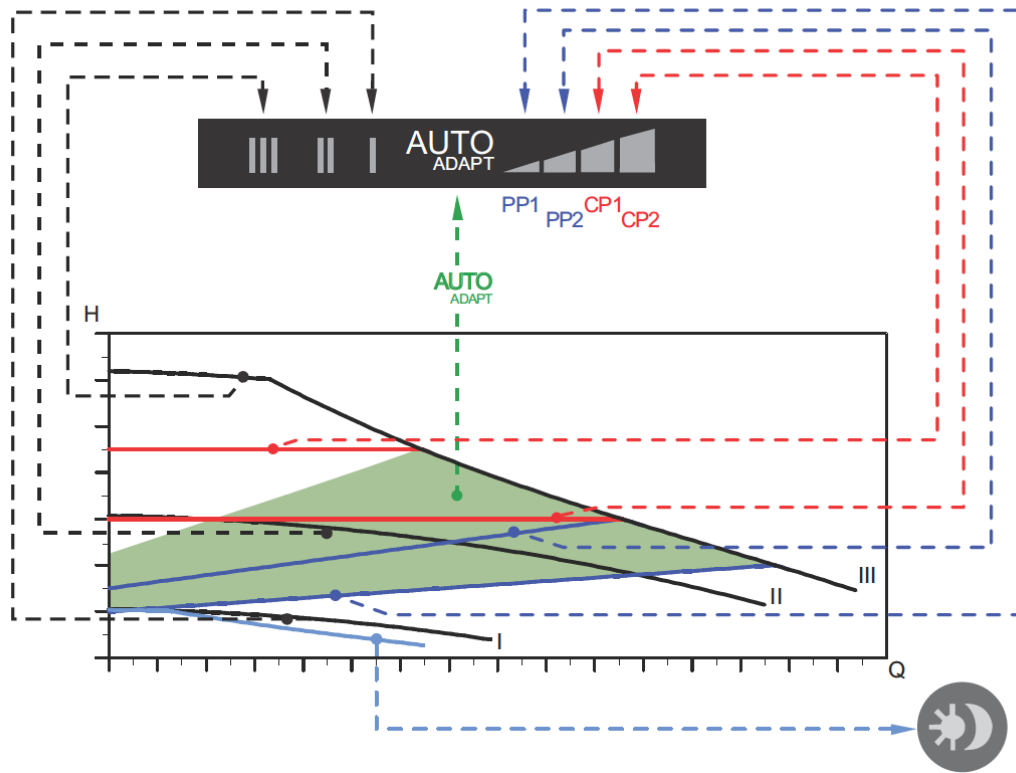


**Figure B 8. UPS 15-50 Performance curve (Grundfos)**

The UPS is either the 15-50 or 15-60 where 15 represents nominal bore and 50 or 60 the pressure. The 50 produces 5 metres head pressure (50kPa) whereas the 60 is for bigger domestic heating systems with higher resistance up to 60 kPa. The traditional fixed speed pump operates with 3 speed settings, and is usually left by installers on III but sometimes on II. Grundfos provide power ratings for each speed:

- 15-50 on II 45 W, on III 50 W.
- 15-60 on II 60 W, on III 70 W.

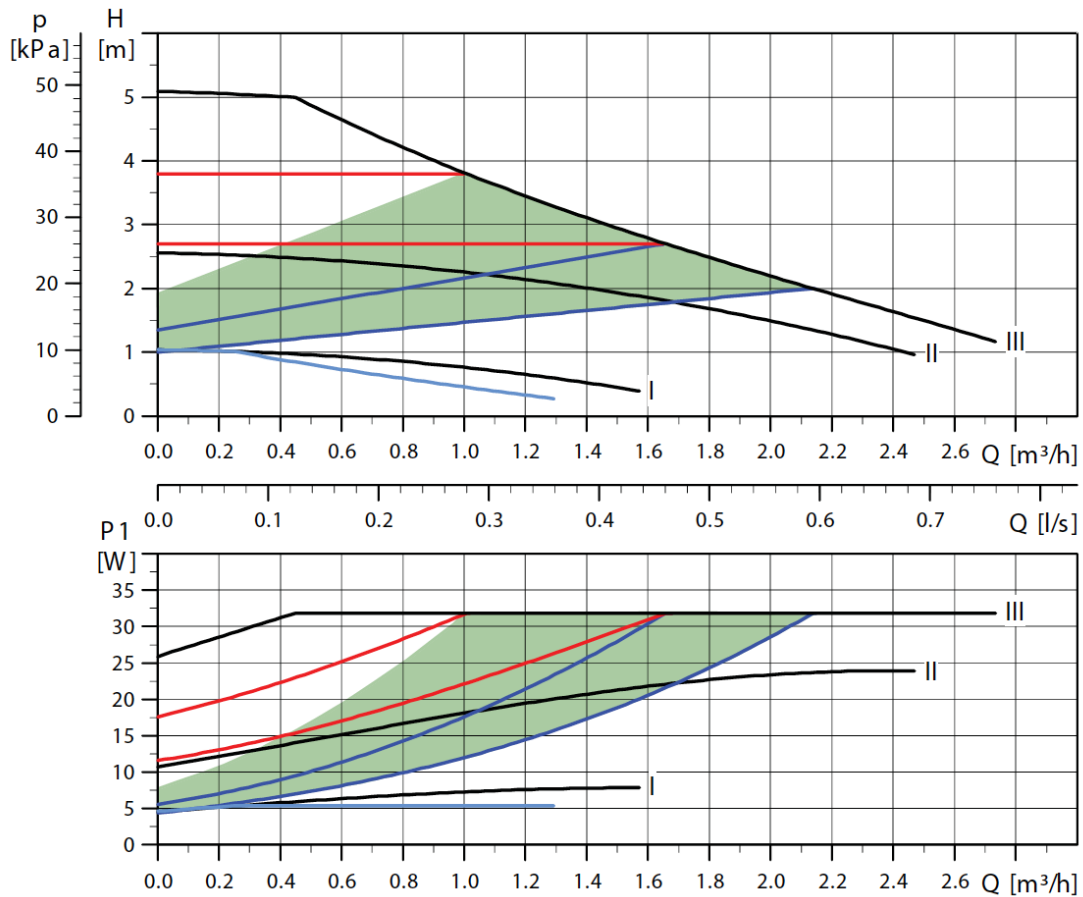
The UPS 15-50 and 60 range has been updated with the ALPHA2 15-50 and ALPHA2 15-60. Grundfos has retained the numerical suffix for good reasons, however, we cannot distinguish from the metadata whether the numerical description is for the UPS or the ALPHA as this is not explicitly specified in many cases.



**Figure B 9. ALPHA, pump setting performance (Grundfos)**

Since variable speed pumps are ideal for heating systems with thermostatic radiator valves (TRV) radiator control, the best setting is proportional – as TRVs close and the pressure rises, the pump speed reduces. Grundfos suggest Constant Pressure for underfloor heating or open systems (those without a pressure vessel).

Here the installer is presented with a dilemma based on the pump control set up. The Alpha has eight settings: “Autoadapt”, two for proportional pressure, two for constant pressure and three for constant speed. The default is Autoadapt but since constant speed is marked I, II and III, plumbers in the UK may well stick to these familiar settings, particularly III, with new pumps resulting in sub-optimal performance.



**Figure B 10. ALPHA 15-50, pressure flow and power (Grundfos)**

Figure B 10 shows that power varies depending on the system flow rate but lies in the range of:

- ALPHA2 15-50 (10 – 17 W minimum) up to 30 W max. We have a pump that barely produces 1 Wh and is designed to provide less.
- ALPHA2 15-60 ranges from (10-22 W minimum) up to 40 W. This is for larger systems, perhaps 10 kW up to about 15 kW.

The Magna is really for larger systems but since it is variable speed it also works with low output boilers and heat pumps. Variations on the range labels, 25-40, 25-60 and 25-80, appear in the metadata:

- MAGNA 25-40 power consumption 10W – 55W
- MAGNA 25-80 (10 – 20W min) - 120W. Note that 120 Watts is for 18 to 25kW installations. In other words larger than virtually all pumps in the trials.

Given the level of technical knowledge needed to understand and apply pump performance graphs, it is likely both pump selection and setting are by custom and practice, or rule of thumb; assessing circulation pump power is fraught with uncertainties both for the installer and for the RAPID-HPC analysis.

As discussed in the data quality report, the Preliminary Assessment Matlab code attempts to derive the heating system circulation pump power rating from the monitored data. We have reservations about this approach as it appears that typical circulation pump power consumptions are barely visible with the electricity meter precision of 1Wh per two minutes (30 W) – for example we note from the ALPHA 15-

50 that for variable speed pumps providing 8 kW and operating at a flow and return temperature difference of 5 to 7K (approximately 0.3 to 0.4 litres/second), the flow rate provides a power demand of less than 25 Watts (less than 1 Wh per 2 minutes), and its signal may therefore be lost in system “noise”.

Estimating pump power from the monitored data also requires assumptions to be made regarding the power consumption of other heat pump components which may consume electricity at the same time as the circulation pump, for example the control system, and the derived pump power consumption will be arithmetically complementary to the assumed power consumption of these other components.

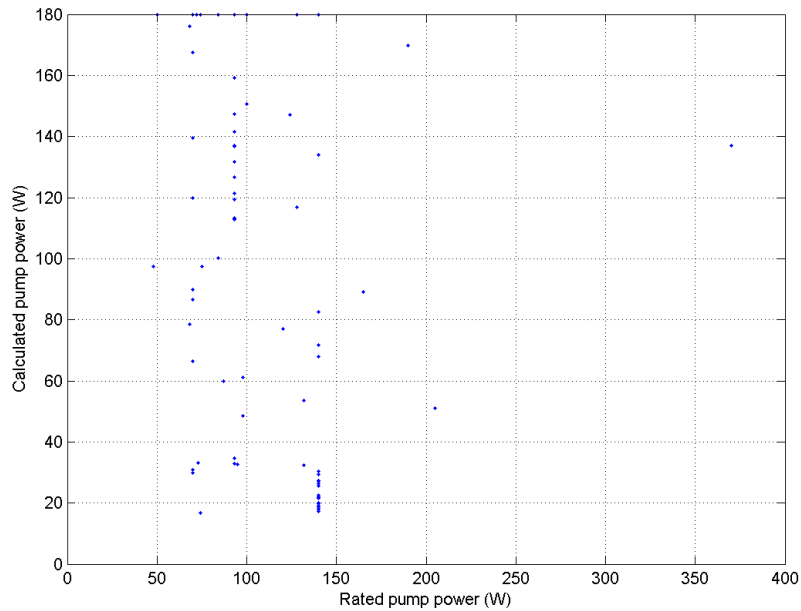
If the pump power consumption can be reasonably accurately estimated from the monitored data, then it is expected that the estimated value would tend to agree with the value recorded in the metadata (though as noted above, there is often some ambiguity with the metadata value). Figure B 11 and Figure B 12 show a comparison of the rated pump power derived from the metadata (either directly specified by the installer or from looking up the power consumption of the specified pump model) and the value calculated by the PA code<sup>13</sup> of 78 sites (where PA code refers to Matlab developed during the preliminary analysis stage and passed to RAPID-HPC), which are the sites meeting the following criteria:

- They are in the analysis dataset.
- The pump is set to the maximum speed setting according to the metadata (so that the actual power consumption is likely to match the rated consumption).
- The pump electricity consumption is included in the heat pump metered supply – for some sites the circulation pump supply is separate from the heat pump supply and so its energy consumption is not included in the metered data.

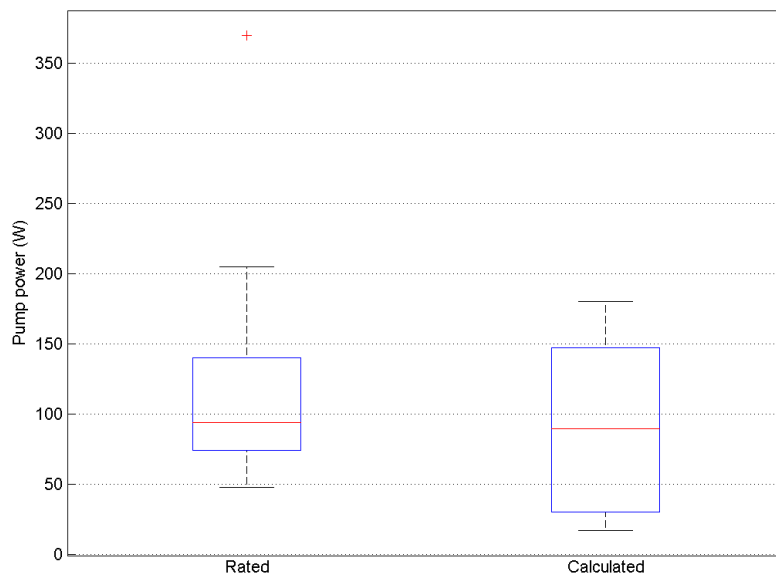
Figure B 11 shows no correlation between the metadata rated pump power and the calculated pump power. Figure B 12 shows that the distributions of the two pump powers are different, with much wider spread in the calculated pump powers, though the median values are reasonably close.

---

<sup>13</sup> This refers to codes used to anonymise installations in the Preliminary Assessment of the RHPP data (Wickins, 2014).



**Figure B 11. Rated pump power from metadata versus pump power calculated from monitored data**



**Figure B 12. Distributions of metadata rated pump power and calculated pump power.**

To illustrate the importance of the assumed pump power rating, Figure B 13 and Figure B 14 show the variation of SPF, heat output and electricity consumption for sites RHPP5772 and RHPP5818 at system boundaries H2, H3 & H4 as the assumed pump power rating is varied from 0 W to 180 W (180 W is the maximum power rating allowed in the PA code). Site RHPP5772 is relatively unaffected by the variation in pump power rating as the pump is active for only around 20% of the year, so total pumping energy is low. Site RHPP5818 is much more affected as the pump is active for around 80% of the year. Note that neither of these sites have immersion or booster heating (so the results for system boundaries H3 and H2 are identical) and these sites have been chosen as the annual heat output is roughly similar.

Figure B 15 shows the variation in median SPF, annual heat output and annual electricity use across the analysis dataset if the same pump power rating is assumed across all sites, for example if the pump rated power (the x-axis) is fixed at 60W, the calculation assumes that if the pump is operating at the maximum flow rate observed for that site, then 60W of electrical power is consumed. Pumping energy consumption is then determined by the number of hours of operation of each circulation pump. This could be thought of as having identical circulation pumps installed at each site.

Some correlation between annual heat output, system mass flow rate and pump power rating might be expected: sites with a lower heat output and lower mass flow rate presumably have a lower pumping requirement and hence can have smaller pumps installed. Accordingly, Figure B 16 shows the same results but with the pump ‘power to volume flow rate ratio’ fixed across all sites, so that sites with higher mass flow rates will tend to have a higher pump energy consumption. For example if pump power to volume flow rate ratio (the x-axis) is fixed to 360W/kg/s, then a system with a maximum mass flow rate of 0.25kg/s (which is fairly typical for the RHPP systems) would have a pump power consumption of 90W when the pump is at the maximum flow rate for that site. A system with a lower maximum flow rate of 0.125kg/s would have a pump power consumption of 45W. The two figures show that the median values are relatively unaffected by the choice of fixing absolute pump power rating versus fixing the pump power per volume flow rate (although results for sites with high or lower than typical flow rates will be affected).

However as discussed previously, whether or not pump power varies with system size, in practice is open to debate: it is not necessarily the case that installers choose smaller pumps for smaller systems, this could perhaps be determined in part from the metadata.

For the remainder of this report, we make the assumption that the rated pumping power divided by design flow rate is 240W/l/s, where design flow rate is calculated as the 95th percentile of the recorded flow rates of a particular site (to avoid being skewed by any anomalously high readings). For a system with a design flow rate of 0.25kg/s this is equivalent to a rated pumping power of 70W (which as noted previously is equal to the rated power consumption of a single Grundfoss UPS 15-60 on speed setting 3, which is a relatively high capacity pump operating at maximum speed).

There is little evidence to support choosing 240W/l/s versus e.g 200W/l/s, or even to support a rated power consumption proportional to design flow rate, however as demonstrated previously the impact on the results is likely to be modest: if we double the assumption to 480 W/l/s then median  $SPF_{H2}$  would increase by 0.1<sup>14</sup> (and certainly we expect the pumping energy to be lower than this for the majority of sites – it would be unusual to require more than two of these pumps), if we set the pump power to zero

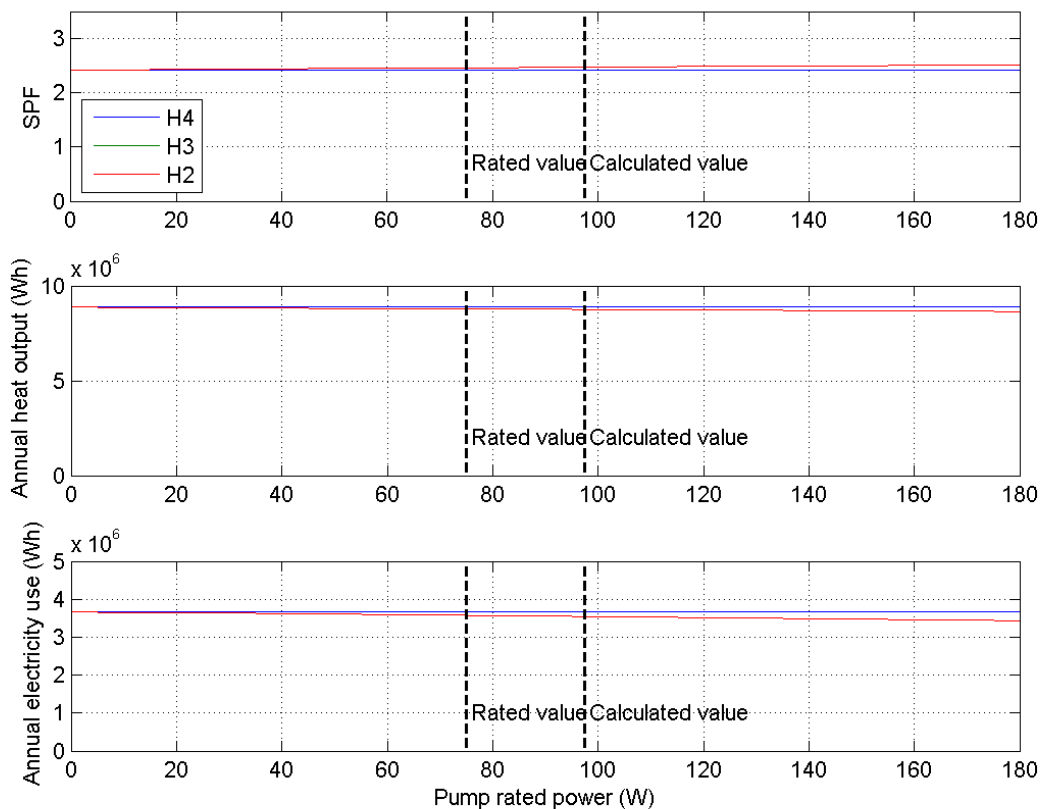
---

<sup>14</sup> This is counterintuitive – in reality, increasing pump electricity use will decrease  $SPF_{H4}$ , leaving  $SPF_{H2}$  essentially unaffected, but here the measurement of  $SPF_{H4}$  is fixed and an assumed pump electricity use is being subtracted, the larger the assumption the greater the difference between  $SPF_{H2}$  and  $SPF_{H4}$  and since  $SPF_{H4}$  is fixed that means  $SPF_{H2}$  must increase.

then median  $SPF_{H2}$  would decrease by 0.1 (and certainly we expect the pump power to be more than zero).

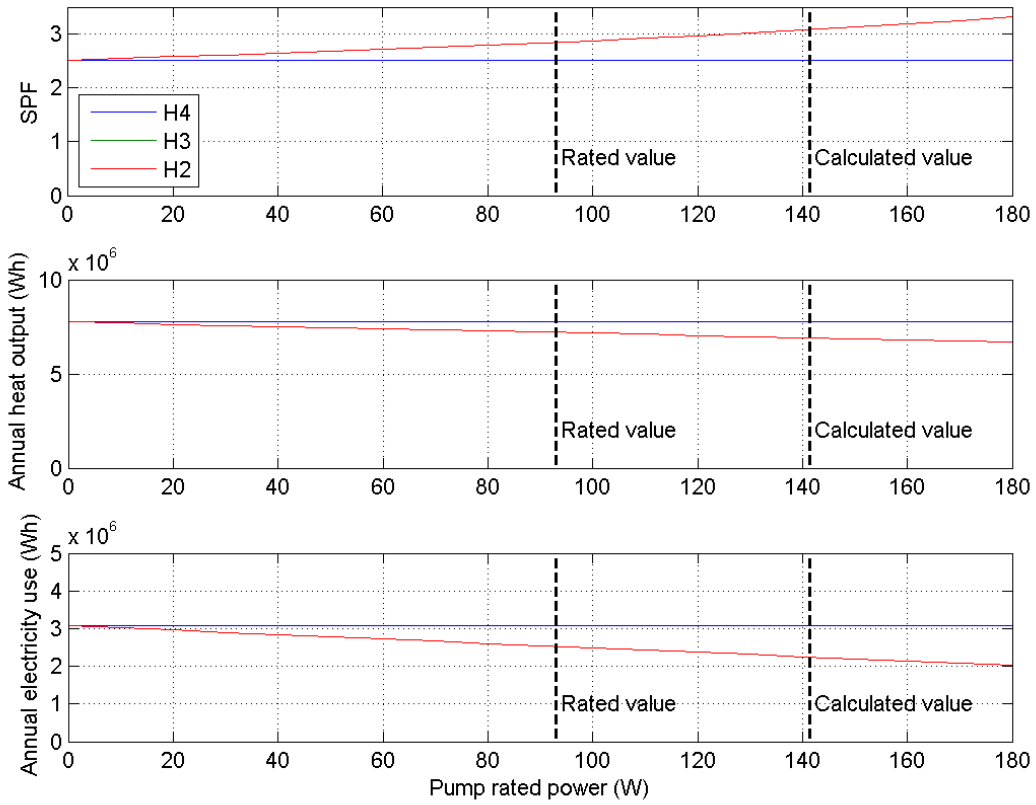
A further area for investigation is what proportion of electricity consumed by the circulation pump appears as heat in the heating circuit: the electricity consumed by circulation pumps will dissipate as heat to both the fluid in the heating circuit and from the casing of the pump. In the PA code and throughout this report it has been assumed that 100% of the electricity consumption of the pump is transferred as heat to the heating circuit, in practice a lower figure will be transferred, perhaps as low as 50%.

The conclusion from the work presented in this section is that circulation pump energy consumption is an area that is poorly understood and that would require further research and direct monitoring if a more accurate understanding was desired. With increasingly stringent EC standards for the performance of new domestic circulation pumps (European Commission, 2009b) and the increasing use of variable speed pumping arrangements it is expected that demand side pumping energy will shrink dramatically for new installations and so  $SPF_{H4}$  will converge towards  $SPF_{H3}$ , and this area of uncertainty will become increasingly irrelevant.

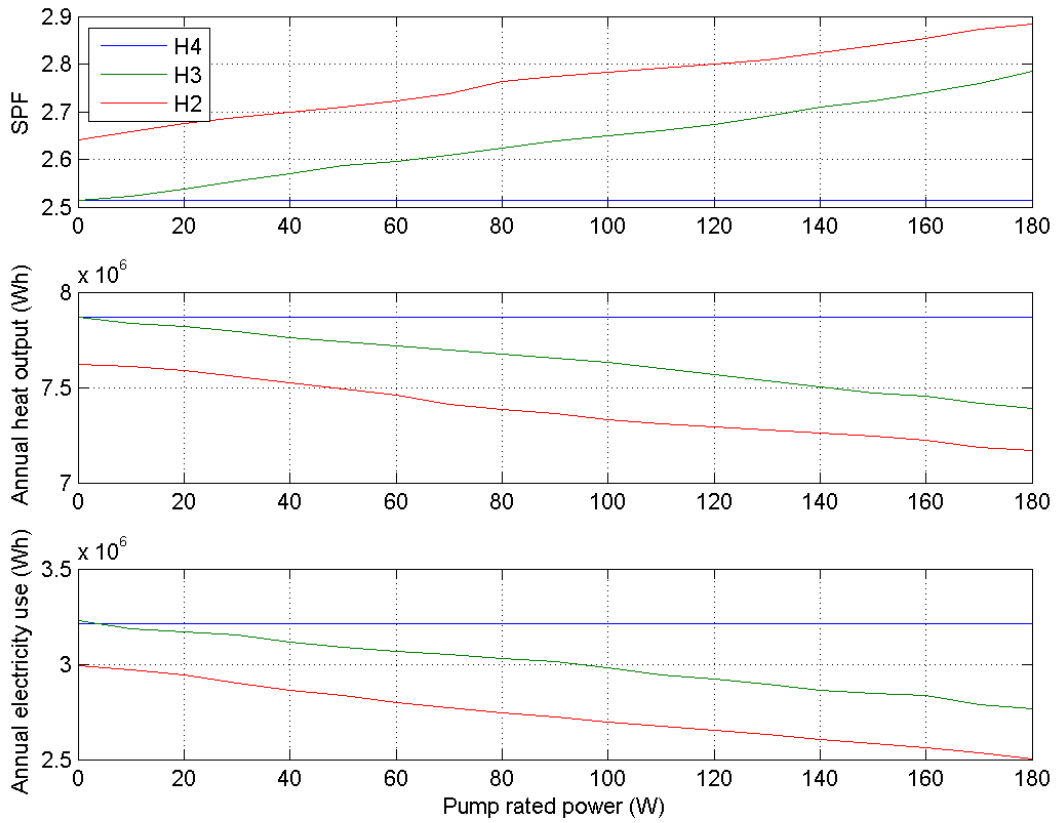


**Figure B 13. Effect of assumed pump rated power on results for site RHPP5772. The 'calculated value' is the value calculated using the algorithm in the PA code, the 'rated value' comes from the metadata.**

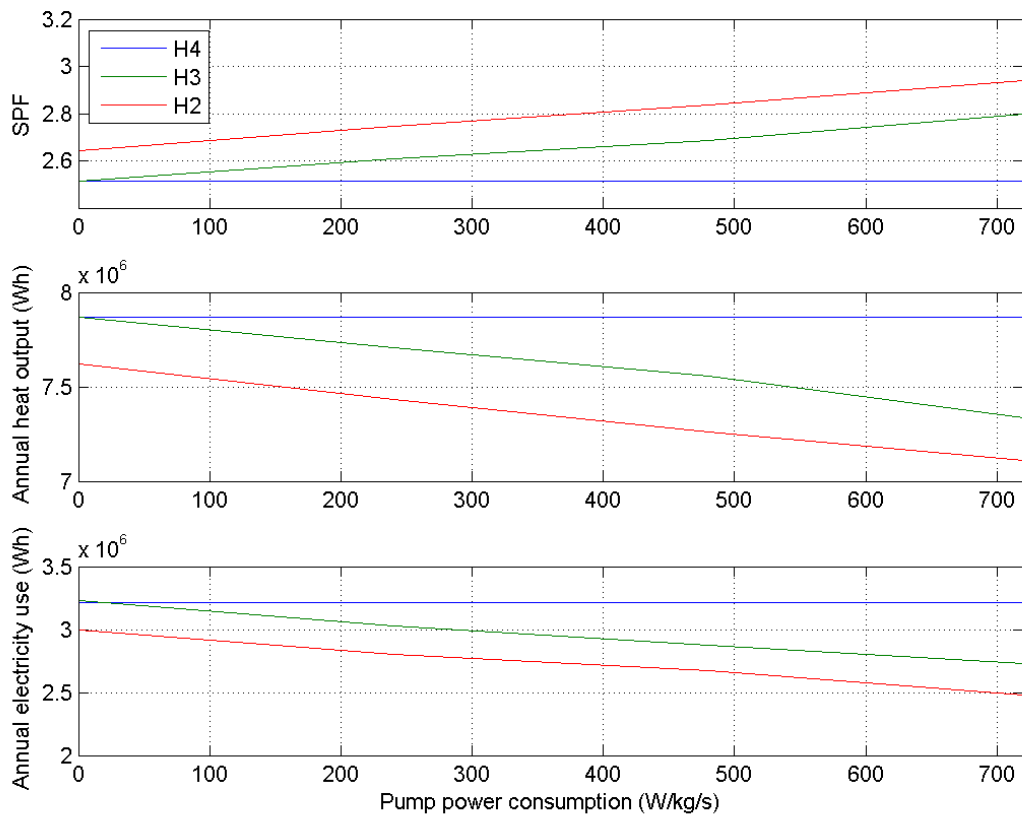




**Figure B 14. Effect of assumed pump rated power on estimated  $SPF_{H2}$  and  $SPF_{H3}$  for results for site RHPP5818.**



**Figure B 15. Effect of fixing pump power rating across all sites in the 80% availability dataset.**



**Figure B 16. Effect of fixing pump power consumption per volume flow rate across all sites in the 80% availability dataset.**

UCL **ENERGY**  
INSTITUTE



UNIVERSITY OF  
WESTMINSTER

